

# electriciQ

## USER AND INSTALLATION MANUAL



| WHITE   | BLACK    |            |
|---------|----------|------------|
| iQool9  | iQool9B  | 9,000 BTU  |
| iQool12 | iQool12B | 12,000 BTU |
| iQool18 | iQool18B | 18,000 BTU |
| iQool24 | iQool24B | 24,000 BTU |

### SMART WIFI CONTROLLED WALL MOUNTED INVERTER SPLIT AIR CONDITIONER WITH HEAT PUMP

Thank you for choosing an electriciQ Air Conditioner  
Please read this user manual before using this innovative  
Air Conditioner and keep it safe for future reference.

# CONTENTS

|  |           |
|--|-----------|
| <b>CONTENTS</b>  | <b>2</b>  |
| <b>SAFETY INSTRUCTIONS</b>                                       | <b>3</b>  |
| <b>OPERATION</b>   | <b>5</b>  |
| <b>INDOOR UNIT</b>   | <b>6</b>  |
| <b>OUTDOOR UNIT</b>  | <b>6</b>  |
| <b>REMOTE CONTROL</b>  | <b>7</b>  |
| <b>SETTING UP THE REMOTE</b>                                     | <b>8</b>  |
| <b>DISPLAY PANEL</b>   | <b>8</b>  |
| <b>FUNCTIONS</b>   | <b>9</b>  |
| <b>WIFI CONTROL</b>  | <b>12</b> |
| <b>BEFORE YOU START</b>  | <b>12</b> |
| <b>DOWNLOAD THE APP TO YOUR PHONE</b>                            | <b>12</b> |
| <b>ACTIVATING THE APP</b>  | <b>13</b> |
| <b>REGISTER THE APP</b>  | <b>13</b> |
| <b>EMAIL REGISTRATION</b>  | <b>13</b> |
| <b>SMS REGISTRATION</b>  | <b>14</b> |
| <b>FORGOTTEN PASSWORD</b>  | <b>14</b> |
| <b>CONNECTION METHODS AVAILABLE FOR SETUP</b>                    | <b>15</b> |
| <b>CHANGING BETWEEN CONNECTION TYPES</b>                         | <b>15</b> |
| <b>ADDING A DEVICE</b>   | <b>15</b> |
| <b>CONNECTING USING CF MODE (QUICK CONNECTION)</b>               | <b>16</b> |
| <b>CONNECTING USING AP MODE (ALTERNATIVE METHOD)</b>             | <b>17</b> |
| <b>USING THE TIMER FUNCTION</b>                                  | <b>20</b> |
| <b>MORE SETTINGS</b>   | <b>21</b> |
| <b>MAINTENANCE</b>   | <b>22</b> |
| <b>END OF SEASON</b>   | <b>23</b> |
| <b>START OF SEASON</b>   | <b>23</b> |
| <b>REPLACING THE BATTERIES</b>                                   | <b>23</b> |
| <b>INSTALLATION GUIDE</b>  | <b>24</b> |
| <b>TOOLS RECOMMENDED FOR INSTALLATION</b>                        | <b>27</b> |
| <b>INFORMATION REGARDING THE INSTALLATION OF THE INDOOR UNIT</b> | <b>29</b> |
| <b>INSTALLATION OF THE OUTDOOR UNIT</b>                          | <b>30</b> |
| <b>CONDENSATE DRAINAGE OF THE OUTDOOR UNIT</b>                   | <b>30</b> |
| <b>INSTALL THE WATER DRAINAGE PIPE</b>                           | <b>32</b> |
| <b>ELECTRICAL CONNECTION OF THE AIR CONDITIONER</b>              | <b>34</b> |
| <b>ELECTRICAL WIRING DIAGRAMS</b>                                | <b>34</b> |
| <b>TROUBLESHOOTING AND SELF DIAGNOSIS</b>                        | <b>36</b> |
| <b>WIFI CONTROL TROUBLESHOOTING</b>                              | <b>40</b> |
| <b>TECHNICAL SPECIFICATION</b>                                   | <b>41</b> |
| <b>APPENDIX</b>  | <b>42</b> |

## SAFETY INSTRUCTIONS

### IMPORTANT!

- Carefully read the instructions before operating the unit
- This appliance comprises of an indoor and an outdoor unit. The indoor slim evaporator is designed exclusively for indoor installations while the external condenser can be installed outside while still away from flood water or snow line.
- Always place the unit on a dry and stable surface. Install the outdoor unit on a wall with wall-mounting brackets or fix to a floor slab with special floor mounting slab bolts or brackets away from flood or snow lines.
- Rating: This unit must be only connected to a 220-240 V / 50 Hz earthed power source.
- Installation must be in accordance with the regulations of the country where the unit is used.
- This appliance is intended for permanent installation into a fixed structure, and should not be installed on vehicles.
- The outdoor part of the air conditioner unit must always be stored and transported upright, otherwise irreparable damage may be caused to the compressor; if in doubt we suggest waiting at least 24 hours before starting the unit.
- These air conditioners are supplied with pre flared refrigeration pipes and electrical cables, which enables the installer to reduce the installation time.
- European Union regulations requires for an F-Gas trained engineer to handle any operation where non-qualified intervention could cause fluorinated gas to escape. A commissioning certificate must be issued with any installation.
- This air conditioner contains R32 which is a safe efficient refrigerant which has a lower environmental burden than traditional refrigerants.
- The refrigerant used in this air conditioner is an environmentally friendly hydrocarbon R32, which has a very low Global Warming Potential compared to traditional refrigerants.
- R32 is classed as slightly flammable and as such naked flames and sources of ignition should be kept a safe distance from the unit.
- If you are in any doubt about the suitability of your electrical supply have it checked and, if necessary, modified by a qualified electrician.
- This air conditioner has been tested and is safe to use. However, as with any electrical appliance - use it with care.
- Disconnect the power before dismantling, assembling or cleaning.
- Never connect the unit to an electrical outlet using an extension cord. Both the indoor unit and outdoor must be hardwired by a qualified electrician.
- Never operate this appliance if the cord is damaged. Ensure the power cord is not stretched or exposed to sharp objects or edges.
- A damaged supply cord should be replaced by the manufacturer or a qualified electrician in order to avoid a hazard.
- Avoid touching any moving parts within the appliance.
- Never insert fingers, pencils or any other objects through the guard
- This appliance is not intended for use by persons (including children) with reduced physical, sensory or mental capabilities. It is also not intended for use by those with a lack of experience and knowledge, unless they have been given supervision or instruction concerning the use of the appliance by a person responsible for their safety. Do not leave children unsupervised with this appliance.

- Do not clean the unit by spraying it or immersing it in water.
- Any service other than regular cleaning or filter replacement should be performed by an authorized service representative or a qualified air conditioning engineer. Failure to comply could result in a voided warranty.
- This air conditioner is intended for cooling / heating a room to a suitable level for human comfort, and should not be used for any other purpose such as cooling food.
- Avoid restarting the air conditioning unit unless 3 minutes have passed since being turned off. This prevents damage to the compressor.
- Never use the mains as a switch to start and turn off the air conditioning unit. Use the provided ON/OFF button located on the remote control.
- The indoor unit should not be installed in laundry or wet rooms.
- Diagrams and pictures provided within the manual are for guidance only. Due to continual product development, if there is any variance between the manual and the product received, the information provided on the product should be followed.

### **ENERGY SAVING AND UNIT SAFETY PROTECTION TIPS**

- Do not cover or restrict the airflow from the outlet or inlet grills.
- For maximum performance the minimum distance from a wall or objects should be 50cm.
- Keep the filters clean. Under normal conditions, filters should only need cleaning once every four weeks (approximately). Since the filters remove airborne particles, more frequent cleaning maybe necessary, depending on the air quality.
- For the initial startup set the fan speed to maximum and the thermostat to 4-5 degrees lower than the current temperature. After, set the fan switch to low and set the thermostat to your desired setting.
- To protect the unit we recommend not using the cooling mode when the ambient indoor temperature is higher than 35°C.
- To protect the unit we recommend not using the heating mode when the indoor ambient temperature is lower than 7°C. Performance will be reduced at lower temperatures.
- Note the manufacturer operating temperature ranges at the end of this user manual.

## OPERATION

### COOLING MODE

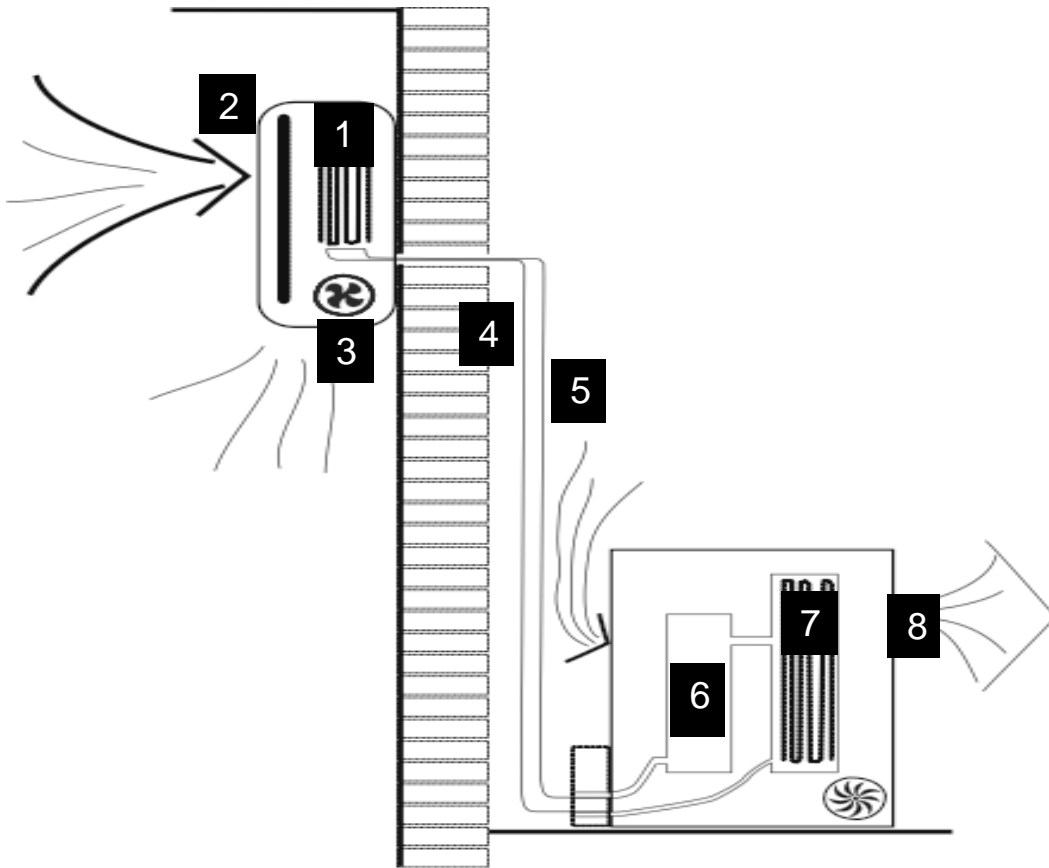

The compressor (6) in the external unit compresses the refrigerant into a high-temperature, high-pressure gas. When this gas flows along the cooling fins of the condenser (7), heat is exuded and the gas condenses into a liquid, which is then led to the evaporator (1) in the indoor unit. The liquid expands into a gas at a low temperature and low pressure. This gas absorbs the warmth of the air in the room, and a fan (3) draws the air through the filter and over the evaporator (1), blowing the cooled air back into the room. The heat is moved to the compressor along with the gas. A fan (8) draws air over the condenser and blows the warm air away.

- |               |                  |                   |
|---------------|------------------|-------------------|
| 1. Evaporator | 2. Filter        | 3. Evaporator Fan |
| 4. Gas Line   | 5. Liquid line   | 6. Compressor     |
| 7. Condenser  | 8. Condenser Fan |                   |

### HEAT PUMP MODE

The system operates in reverse: the condenser works as an evaporator, the evaporator as a condenser: warm air is blown into the room. It is ideal as a maintenance heating when outside temperature is not too low and when the indoor temperature is more than 7°C.

### DEHUMIDIFYING

As with cooling, the moisture in the air condenses on the cold evaporator at room temperature acting as a powerful dehumidifier.

## INDOOR UNIT

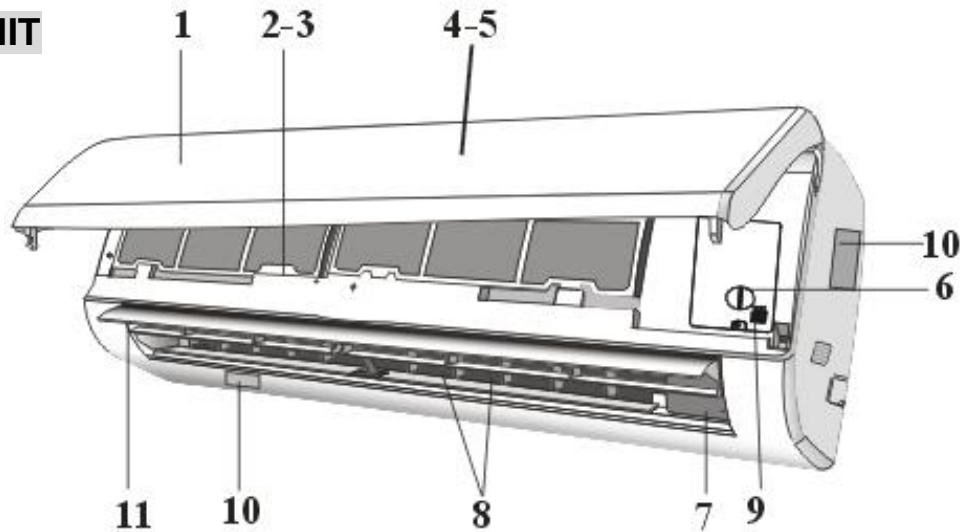

| No. | Description                                      |
|-----|--|
| 1   | Front panel                                      |
| 2   | Air filter                                       |
| 3   | Optional filter                                  |
| 4   | LED Display                                      |
| 5   | Signal receiver                                  |
| 6   | Terminal block cover                             |
| 7   | Ionizer generator (not applicable on all models) |
| 8   | Deflectors                                       |
| 9   | Emergency button                                 |
| 10  | Indoor unit rating label                         |
| 11  | Airflow direction louver                         |

## OUTDOOR UNIT

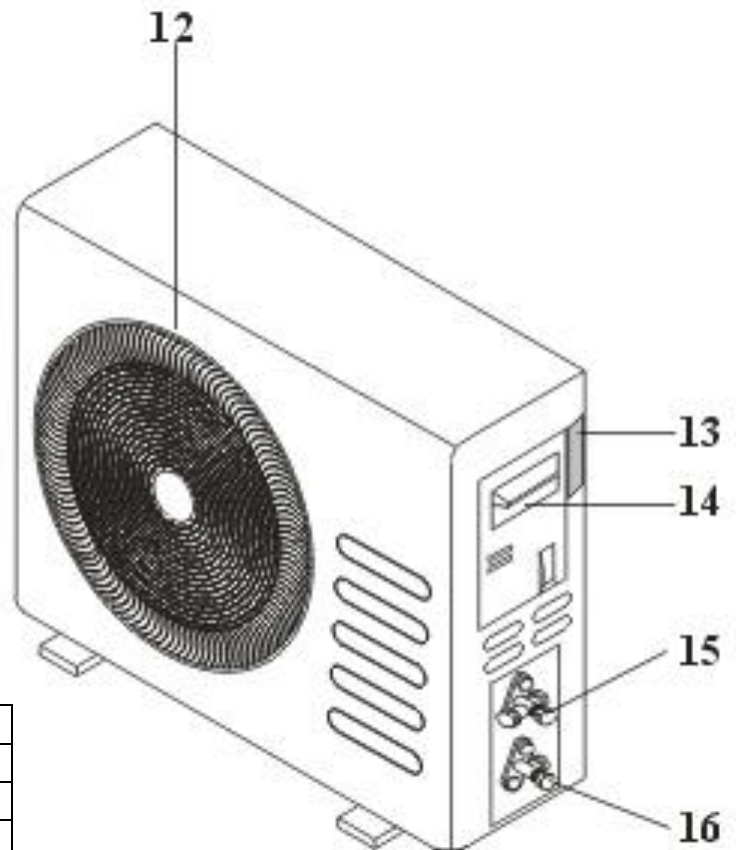

| No. | Description               |
|-----|---------------------------|
| 12  | Air outlet grille         |
| 13  | Outdoor unit rating label |
| 14  | Terminal block cover      |
| 15  | Gas valve                 |
| 16  | Liquid valve              |

## REMOTE CONTROL

The remote control has a range of up to 8m. Point the remote control at the receiver in the interior unit. A beep confirms that the remote control signal has been received.

## REMOTE OPERATION

Turn the appliance on using the **ON/OFF** button. This activates the most recently used setting.

The ON/OFF button also turns the air conditioner off.

\*Horizontal swing not available on most models and the horizontal direction must be adjusted manually.

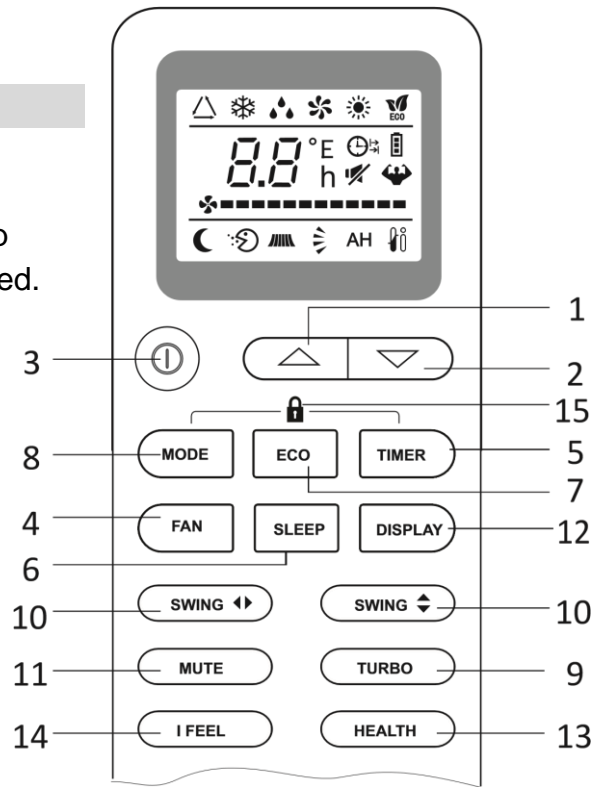

| No. | Button  | Function   | * |
|-----|---|--|---|
| 1   | Down  | Press to decrease the desired room temperature.  |   |
| 2   | Up  | Press to increase the desired room temperature.  |   |
| 3   | Power   | Press to turn the unit on or off.  |   |
| 4   | Fan   | Press to select the fan speed between LOW, MED and HIGH.   |   |
| 5   | Timer   | Press to set the timer.  |   |
| 6   | Sleep   | Press to activate the "SLEEP" function   |   |
| 7   | Eco   | Press to turn eco mode on or off.<br>In cooling mode eco mode slowly increases the desired temperature by 2°C.<br>In heating mode eco mode slowly decreases the desired temperature by 2°C   |   |
| 8   | Mode  | Press to change between the different modes.   |   |
| 9   | Turbo   | Press to activate turbo mode. This will make the unit work in high performance mode to quickly cool or heat the room for a period of 15 minutes. The fan will be set to max, the temperature will be set to either 16°C in cooling mode or 31°C in heating mode. |   |
| 10  | Swing   | Select the vertical direction of airflow (Horizontal direction not adjustable on these models)   |   |
| 11  | Mute  | Press to turn off the beep when functions are selected.  |   |
| 12  | Display   | Press to turn on/off the LED display.  |   |
| 13  | Health  | Press to activate the ioniser function (Not applicable to certain models)  |   |
| 14  | I Feel  | Press to activate the follow me function.  |   |
| 15  | <br>(MODE+TIMER) | Press to activate the child lock function. All buttons on the remote are locked until the child lock is deactivated.   |   |

## TEMPERATURE

The desired temperature is set with the up and/or down button, within the limits of the thermostat: 16°C – 31°C.

Use the **FAN SPEED** button to set the fan speed at low, medium and high; or automatic (the symbol on the display will flash). The fan speed in the automatic setting is determined by the difference between the set temperature and the room temperature.

## SETTING UP THE REMOTE

When batteries are first inserted into the remote or following changing the batteries, the remote must be set up for COOLING AND HEATING or COOLING ONLY.

When the batteries are inserted the cool and heat symbols will alternate on the screen of the remote. For HEATING AND COOLING press any button while the heat symbol is shown.

If the remote is set up for the wrong type of unit, simply remove the batteries and reinsert, before following the step above.

## DISPLAY PANEL

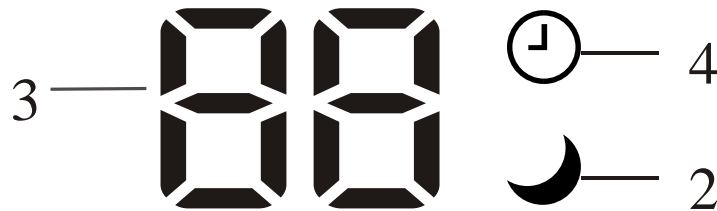

| No. | Display            | Function                            |
|-----|--------------------|-------------------------------------|
| 2   | SLEEP              | Illuminated in sleep mode           |
| 3   | Temp. / Error code | Shows the temperature / error code  |
| 4   | TIMER              | Illuminated when timer is activated |



## FUNCTIONS

### COOL

1. Press the **MODE** button until the **COOL** indicator appears.
2. Set the desired temperature.
3. Use the **FAN** button to set the fan speed.

### HEAT

1. Press the **MODE** button until the **HEAT** indicator appears
2. Set the desired temperature.
3. Use the **FAN** button to set the fan speed.

### FAN MODE

1. Press **MODE** button until the **FAN** indicator appears.
2. The temperature settings are disabled in fan mode.
3. Use the **FAN** button to set the fan speed, cycling through LOW / MED / HIGH / AUTO.

### DEHUMIDIFY

1. Press the **MODE** button until the dehumidify indicator appears.
2. The fan speed will always be low in this mode and the **FAN** button is disabled. In addition the temperature cannot be adjusted in dehumidifying mode

### AUTO MODE

1. Press the **MODE** button until the **AUTO** indicator appears.
2. The difference between the set temperature and room temperature determines how the air conditioner operates: cool, heat, fan or dry. It is not possible to change the temperature in this mode the unit will operate to achieve best performance. The operation logic is as below.

| Ambient Temperature | Operation Mode | Auto Temperature |
|---------------------|----------------|------------------|
| <20°C               | Heating        | 23°C             |
| 20°C - 26°C         | Dry            | 18°C             |
| >26°C               | Cool           | 23°C             |

3. Use the **FAN** button to set the fan speed.

### TIMER OFF FUNCTION (WHILE THE AIR CONDITIONER IS ON) →

1. Press the **MODE** button until the symbol appears for the operation you want.
2. Set the desired temperature.
3. Use the **FAN** button to set the fan speed.
4. Press the **TIMER** button to set the running time required. Use the up and down buttons to set the running time in 30 minute intervals (max 24 hours). Once the running time has elapsed, the appliance will switch itself off. To cancel the timer function before the set time has elapsed, press the **TIMER** button again.

### TIMER ON FUNCTION (WHILE THE AIR CONDITIONER IS IN STANDBY) →

1. The appliance is switched off in standby mode
2. Press the **TIMER** button to set the number of hours until switch on is required. Use the up and down button set the number of hours in 30 min intervals (max 24 hours). Set the desired operation, temperature, fan speed. Once the set time has elapsed, the appliance will switch itself on. To turn off the timer function before the set time has elapsed, press the **TIMER** button again.



## SLEEP MODE

1. Press the **SLEEP** button
2. Set the desired temperature.
3. Press the **SLEEP** button; The **SLEEP** indicator will appear on the display. Cancel the sleep mode by pressing the button again.
4. The fan will operate at low speed.
5. The temperature is automatically altered by 1°C every hour for 2 hours. In cooling mode the temperature will rise, in heating it will fall.
6. After 10 hours in Sleep mode the unit will power off automatically.

## TURBO

1. Press the **TURBO** button until the Turbo symbol appears.
2. Set the desired temperature.
3. Use the **FAN** button to set the fan speed
4. Press the **TURBO** button. The fan and compressor will run at maximum speed for 15 minutes, before returning to their previously set levels.

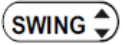
## SWING

1. Press the **SWING** buttons to control the fan direction.
2. The  controls the horizontal air movement (up/down)
3. The  button is not activated on this model, and the horizontal direction of the airflow can be adjusted manually.

## ECO

1. Press the **ECO** button to turn on the energy saving mode
2. In cooling mode, the desired temperature will increase by 2°C.
3. In heating mode, the desired temperature will decrease by 2°C.

## IFEEL

1. Press the **IFEEL** button to activate the follow me mode.
2. In this mode the temperature of the unit will be set based on the temperature where the remote is situated.
3. The remote will act as a mobile thermostat which controls the unit.

## HEALTH

1. Press the **Health** button to activate the antibacterial ioniser function.
2. The ioniser helps to eliminate pollutants in the air.

PLEASE NOTE: The Health mode can only be used on units containing an ioniser.

## **IMPORTANT INFORMATION**

### **HEATING MODE**

When the air conditioner is placed in heating mode, the indoor unit will appear to be inactive while it follows its preheat procedure to heat the evaporator coils. Once the coils have heated, the indoor fan will start to run. This process usually takes 1 – 3 minutes, and is designed to ensure that cold air is not circulated.

### **AUTO RESTART**

The air conditioner will automatically restart when electricity is restored after a power cut. If in doubt, check the settings.

### **RANGE OF INTERNAL THERMOSTAT**

The internal thermostat can be set at a desired temperature between 16 and 31°C. Note that whether the desired value is achieved depends on the room size, temperature and insulation of the room.

### **RANGE OF HEAT PUMP FUNCTION**

The heat function can be used when the external ambient temperature is above -15°C. The performance of the heat pump will degrade with lowering external temperatures. Please note the performance will reduce when the outdoor temperature drops below 5°C.

### **CAPACITY**

The required cooling or heating capacity depends greatly on the location and/or use of the room where the air conditioner is installed. Strong sunlight and the presence of people, lights or equipment creates an additional heat load. Normal living spaces require about 350 Btu per square metre of floor surface. In strong sunlight or if other sources of heat are present, this may be as much as 1200 Btu per sqm.

Tip: On warm days, let the air conditioner cool the room as much as possible during the night and keep the temperature constant from night to daytime.

### **EMERGENCY START**

In the event of a problem, the air conditioner can be operated using the emergency button under the panel in the indoor unit. Open the front panel and press the button, the air conditioner will:  
-heat if the room temperature is 20 °C or less, cool if the room temperature is 25 °C or more and for values in between will operate in fan mode.

## WIFI CONTROL

### BEFORE YOU START

- Ensure your router provides a standard 2.4ghz connection.
- If your router is dual band ensure that both networks have different network names (SSID). The provider of your router / ISP will be able to provide advice specific to your router.
- Once the app has been installed on your phone, turn off the data connection, and ensure your phone is connected to your router via wifi.

### DOWNLOAD THE APP TO YOUR PHONE

Please note that your air conditioner requires a good signal during the setup process. Your air conditioner is designed to be connected to a 2.4ghz network, and the connection is set up using the TCL “SMART LIFE” app. We would advise on using the QR codes below to ensure the correct app is downloaded.



Android



IOS

The unit can also be controlled using the “Smart Life” app by TUYA which is also available in the app stores. We would advise on using the version above which is optimised for use with your air conditioner as we cannot guarantee the correct functionality of all features with the TUYA app. If you would prefer to use the TUYA app, please use the QR codes below



Android



IOS

## ACTIVATING THE APP

The first time the app is used, it will need activating. To do this, either press the scan button, and scan the QR code below, or press “Enter Activation Code” and enter the activation code: electriQ

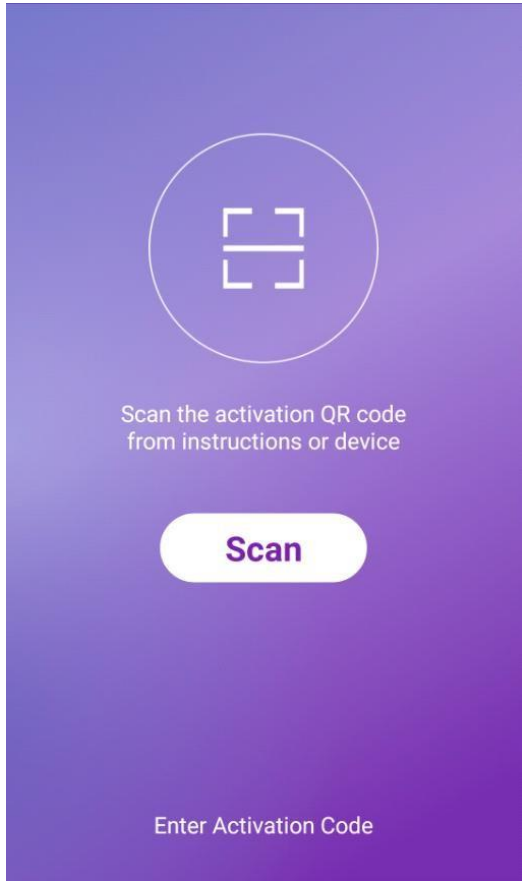

## REGISTER THE APP

Upon the first use, an account will need to be registered. Click on the “Register” button to enter the registration screen. The account can be created by using either the default option of an email address, or alternatively by SMS message using the “Register with mobile number” option.

## EMAIL REGISTRATION

Enter your email address, and Press next. In the password box create a new password for your account, before pressing confirm. This should be at least 6 characters and include letters and numbers.

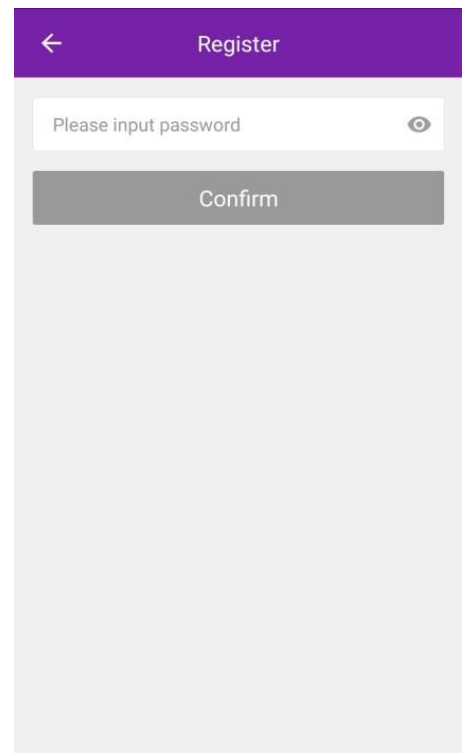
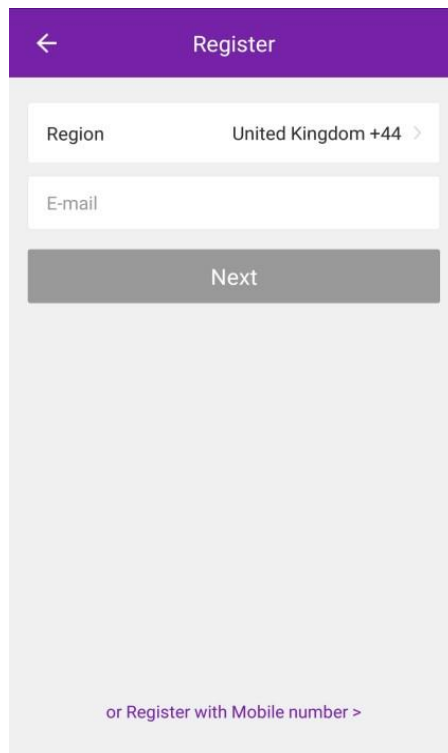

## SMS REGISTRATION

Press on the option at the bottom of the screen to choose the option for registering with a mobile number. You will receive an activation code via SMS. Enter the activation code into the verification code box, before entering your new password in the box below.

Please note the password should be at least 6 characters and include letters and numbers. Then press the confirm button to log in.

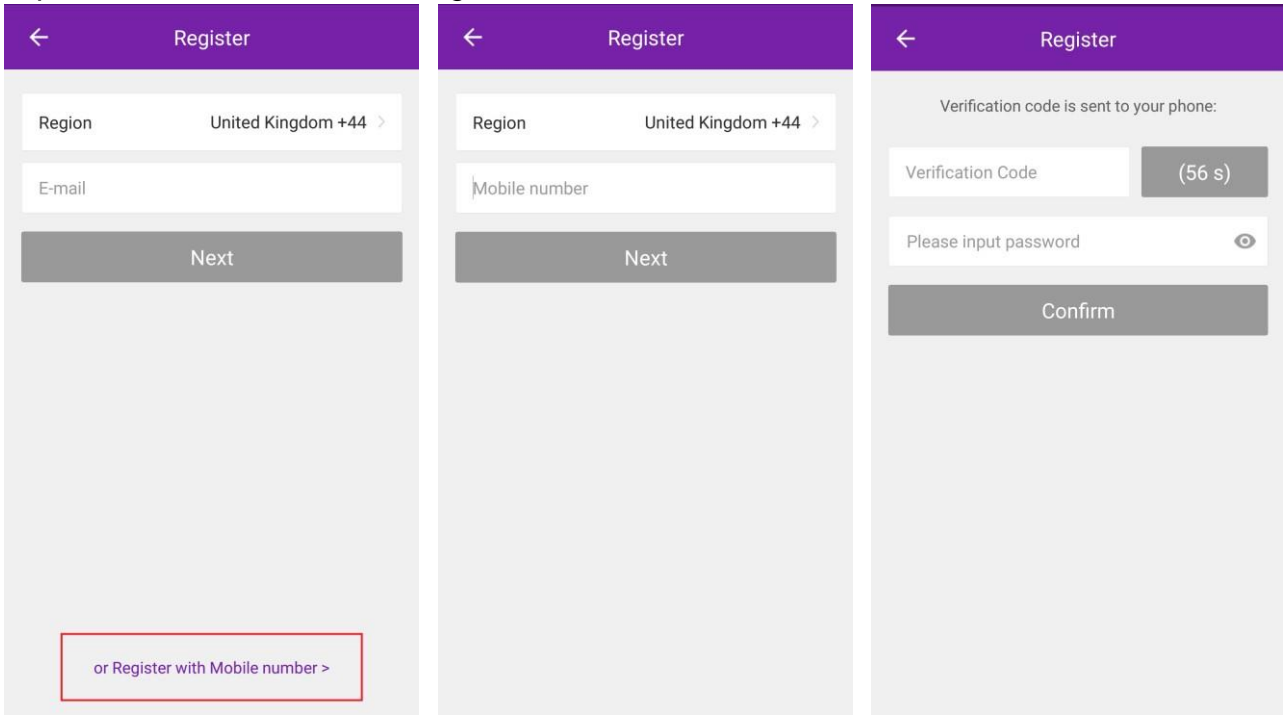

## FORGOTTEN PASSWORD

Should the password for your account be forgotten, it is possible to use the "Forgot Password" option which will allow you to enter the email address or telephone number used to register the account, and a verification code will be sent to you via the method chosen.

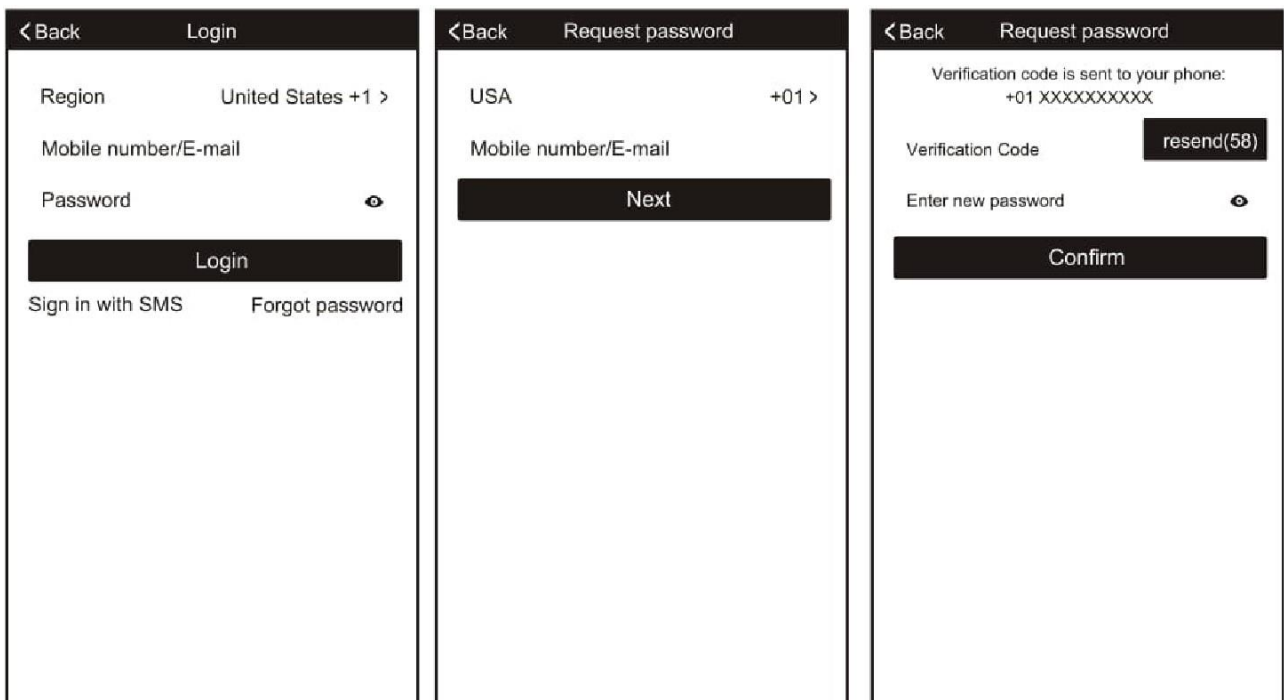

## CONNECTION METHODS AVAILABLE FOR SETUP

The air conditioner has two different setup modes, CF (Quick Connection) and AP (Access Point). The CF mode is a quick and simple way to set the unit up. The AP connection uses a direct local wifi connection between your phone and the air conditioner to upload the network details.

Before starting the setup, please ensure that your air conditioner is in the correct standby mode for the connection type you are attempting, the display on the air conditioner will confirm the current connection mode during setup.

## CHANGING BETWEEN CONNECTION TYPES

To change the unit between the two connection types, quickly press the display button on the remote 6 times, and wait approx. 10 seconds until the new connection mode is displayed on the panel of the air conditioner.

## ADDING A DEVICE

1. Press the “Add device” button, which will bring up a screen to choose the device type.
2. Select “Split Air Conditioner” from the Device Type List.
3. The app will default to quick connection mode, and this can be changed by pressing the button labelled AP Mode in the top right of the screen.
4. After ensuring that the air conditioner is also in the correct connection mode, follow the relevant connection guide on the following pages.

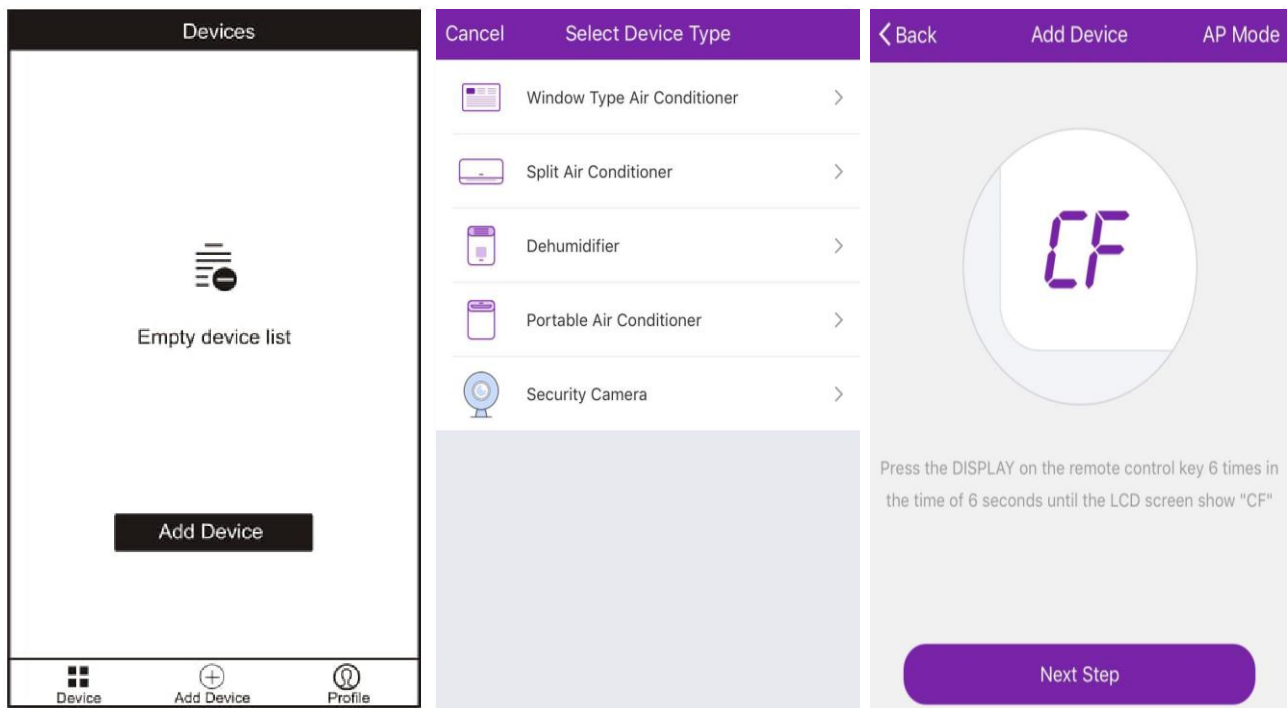

## CONNECTING USING CF MODE (QUICK CONNECTION)

1. Ensure that the display on the air conditioner is displaying CF before pressing “Next Step” (otherwise to change the connection mode: Quickly press the display button on the remote 6 times and wait 10 seconds until CF is displayed)
2. Select your Wifi router from the drop down list and enter the password (Please note the password is case sensitive) before pressing next.

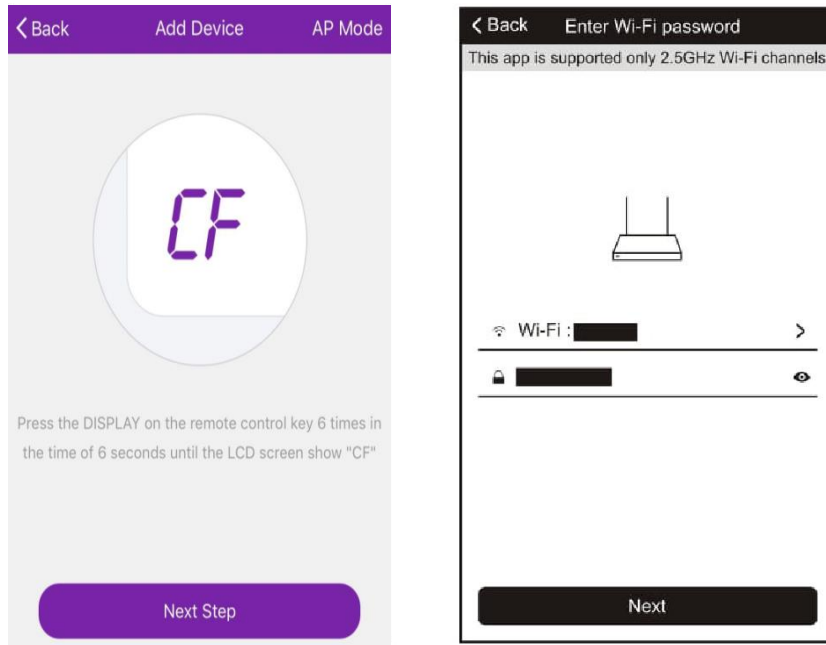

The app will automatically upload the connection information to the air conditioner, once the connection is completed, a message will be displayed to confirm. On this page there is the option to rename the air conditioner to something more relevant.

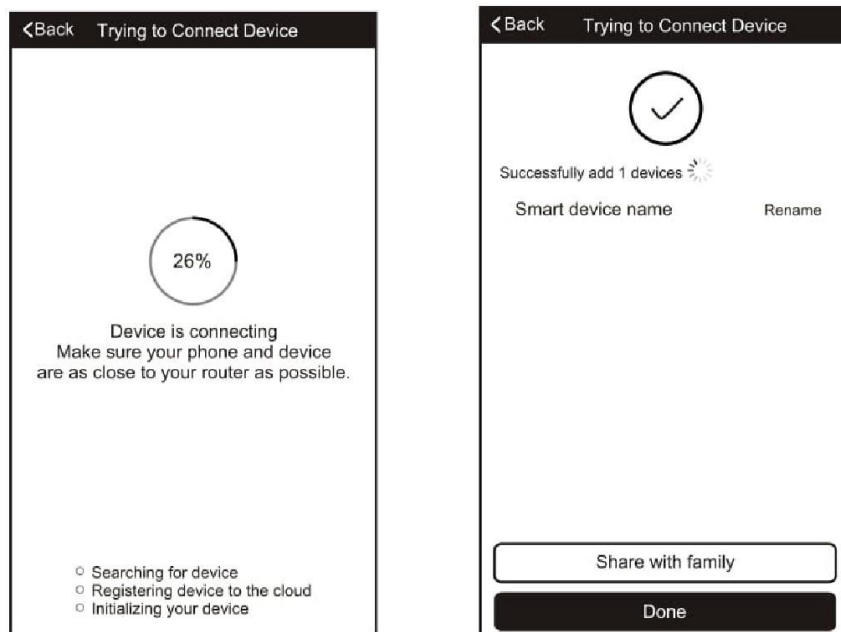

If the connection fails, please retry the connection, failing this try connecting using the AP mode connection.



## CONNECTING USING AP MODE (ALTERNATIVE METHOD)

1. Ensure that the screen on the air conditioner is displaying AP (otherwise to change the connection mode: Quickly press the display button on the remote 6 times and wait 10 seconds until AP is displayed)
2. Press on the AP Mode button in the top right of the screen to change the app to AP mode connection.
3. Select your Wifi router from the drop down list and enter the password (Please note the password is case sensitive) before pressing next.

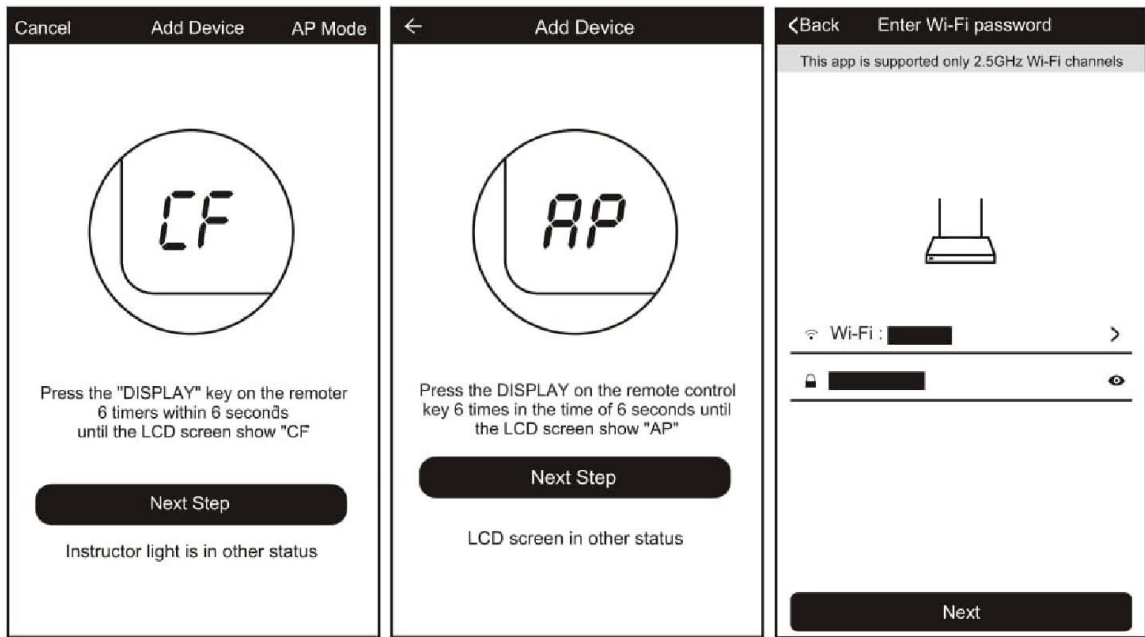

4. Connect your phone to the wifi network by leaving the app, and connecting to the Wifi network created by the air conditioner "Smartlife-XXX"
5. Reopen the app and click on the "Connect now" button,

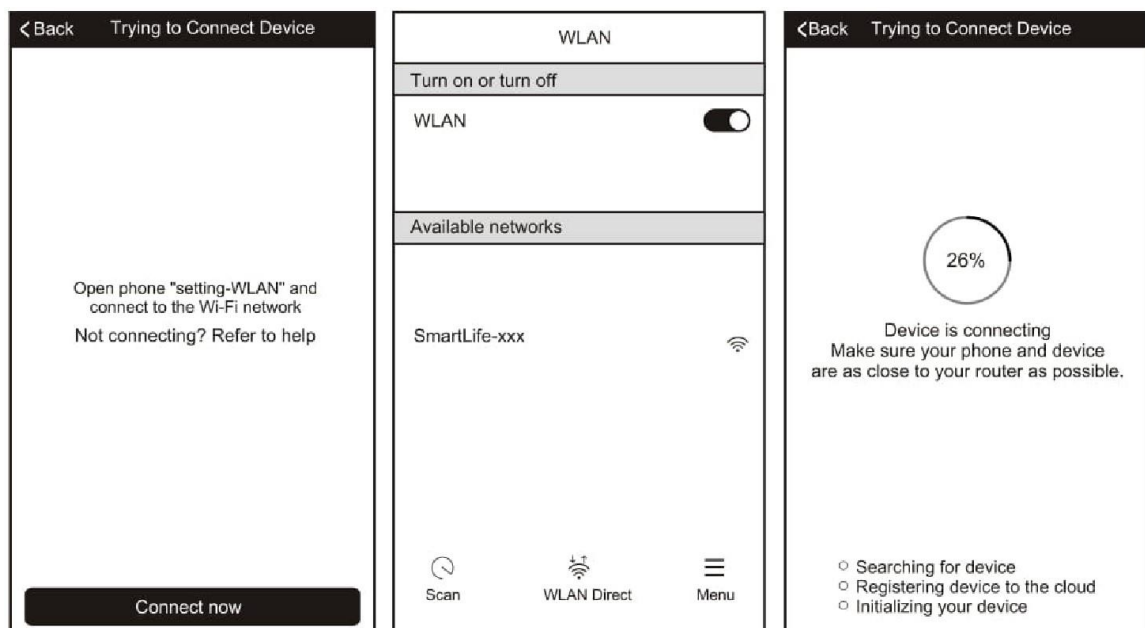

The app will automatically upload the connection information to the air conditioner, once the connection is completed, a message will be displayed to confirm. On this page there is the option to rename the air conditioner to something more relevant.

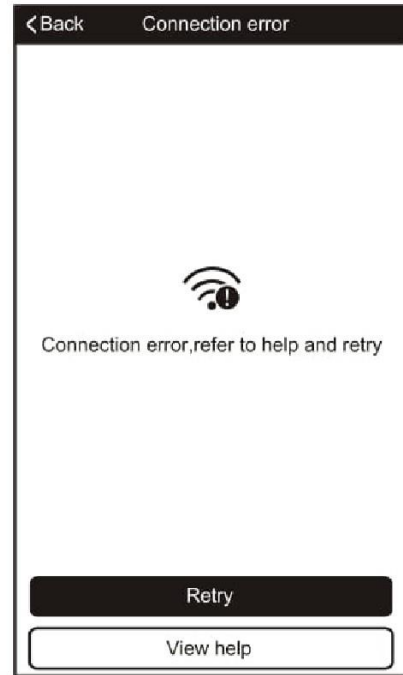
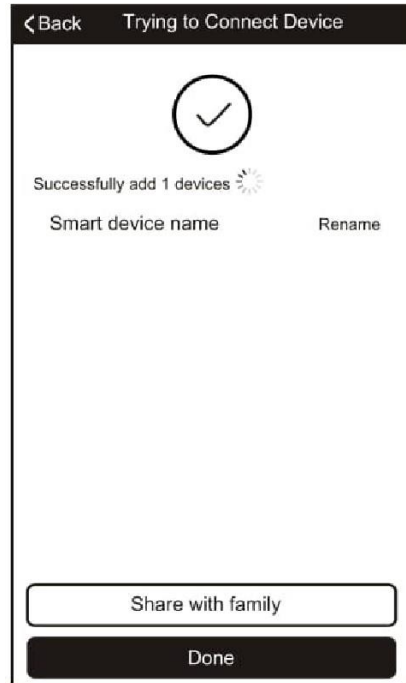

If the connection fails, please retry the connection, failing this try connecting using the CF mode connection.

## CONTROLLING YOUR DEVICE THROUGH THE APP

Now that your air conditioner is linked up to your network, you can control it from your phone. Select your device in the device list to gain access to the controls for the device.

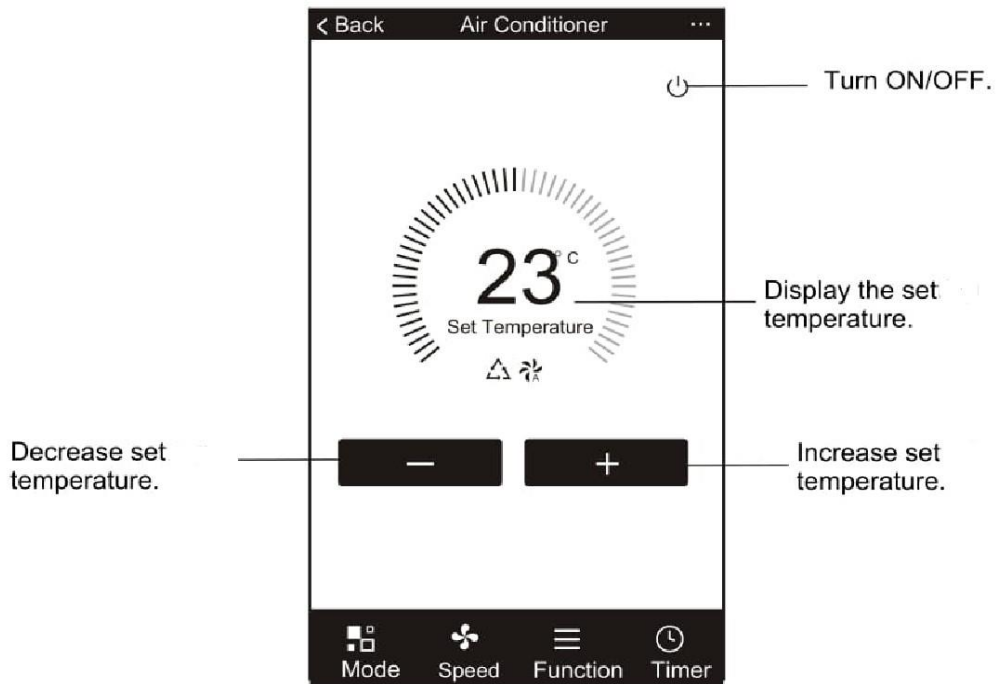

Use the + and – buttons to increase and decrease the desired temperature. The tabs on the bottom of the screen should be used to change other settings.

**Mode:** Allows the operating mode to be changed between Feel, Heat, Dry, Cool and Fan.

**Speed:** Allows the fan speed to be changed between Auto, Low, Medium and High.

**Function:** Allows the Sleep, Turbo and Eco functions to be activated (See main manual for description of the operation) and for vertical and horizontal swing on the louvres to be turned on / off (Not supported on all units)



## USING THE TIMER FUNCTION

The timer can be used to either set a time for the air conditioner to turn on (and specify the settings it will run with), or a time for the unit to turn off. Multiple timers can be used together to build a schedule with on and off times.

1. Press the Timer button at the bottom right of the screen.
2. To set a new timer, press the "Add Timer" button at the bottom of the screen. If there is a timer already programmed that you would like to amend, press and hold the timer which requires amendment.

### OFF TIMER:

1. Select Timer Off
2. Set the time the air conditioner should turn off
3. Select which days the timer should operate
4. Press Save in the top right corner.

### ON TIMER:

1. Select Timer On
2. Set the time the air conditioner should turn on
3. Select which days the unit should run on the auto timer.
4. Set the Mode, fan speed, desired temperature and function that the air conditioner should run with.
5. Press Save in the top right corner.

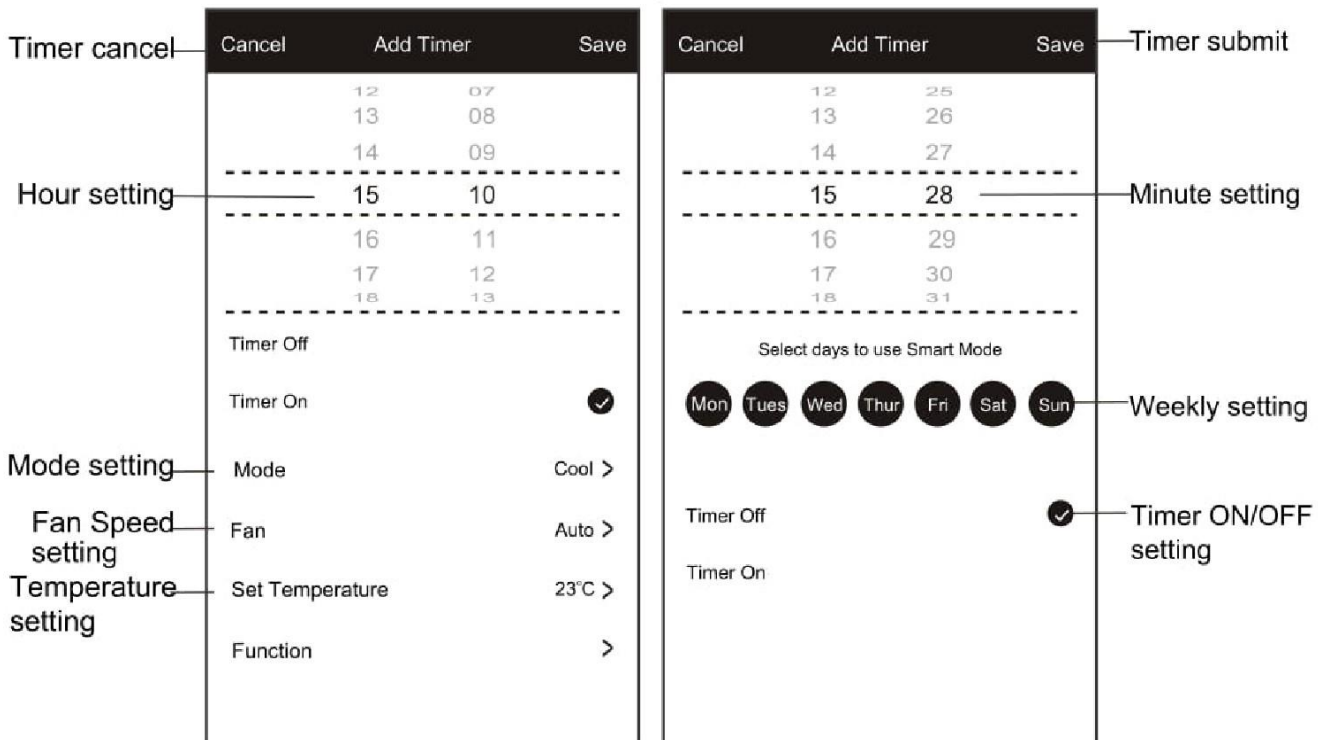

## MORE SETTINGS

When on the main screen the three dots in the top right hand corner give you access to the settings options for the app. This a number of extra options for modifying the name of the air conditioner, and removing a device from the app.

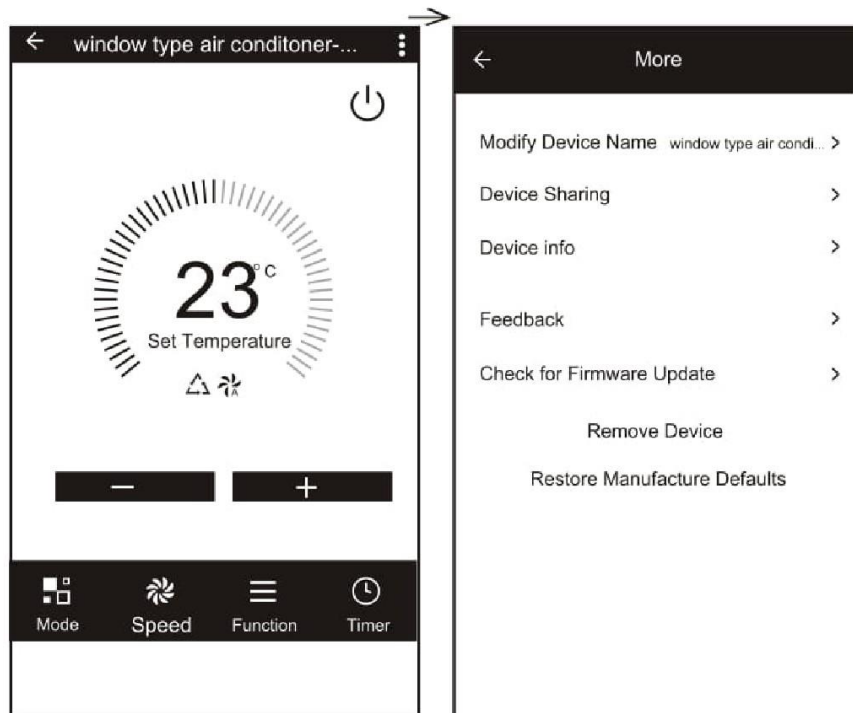

## MAINTENANCE

### FILTERS

Ensure the power is turned off to the unit before attempting to service the filters.

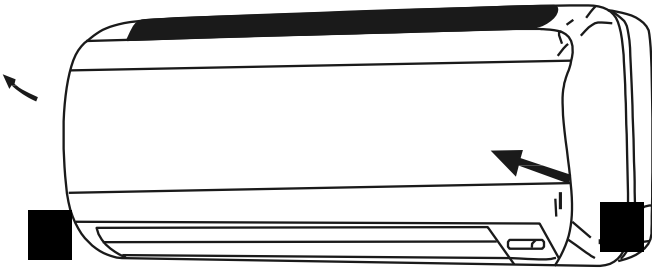

**OPENING THE FRONT PANEL:** At the recesses, pull the front part up with both hands. The front panel will stay horizontal (at around 90°).

**CLOSING THE FRONT PANEL:** Press the front part down at the sides and in the middle. Make sure it is properly clicks into place.

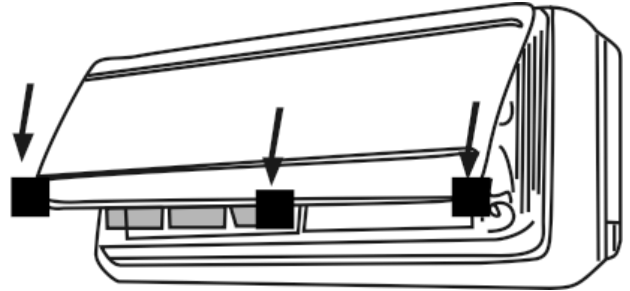

### REMOVING AND REPLACING THE FILTERS

1. Hold the front panel open (or put it in horizontal position) and remove the filter(s).
2. Use a vacuum cleaner to remove dirt. If the dust filter is very dirty, it may be washed in lukewarm water with a very small amount of neutral detergent. Rinse well and allow to dry completely (not in direct sunlight or near a source of heat).

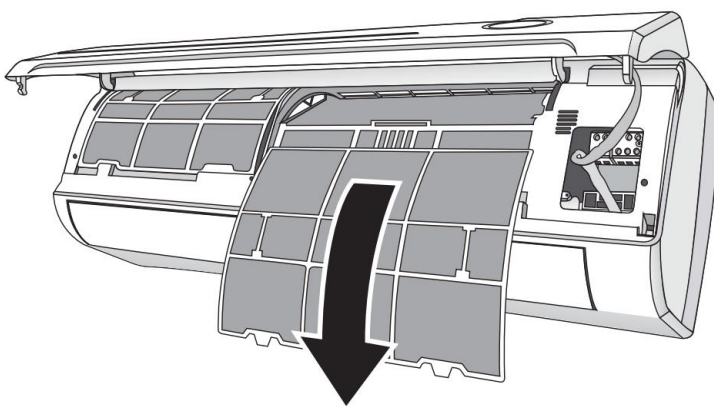
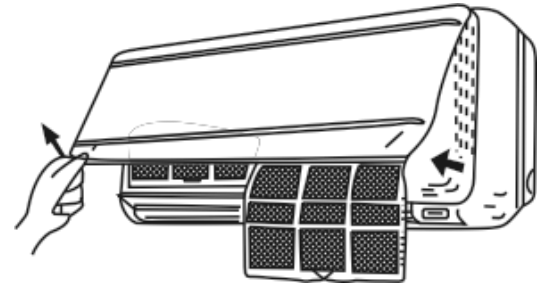

3. Keep the front panel open and reinstall the filter(s). Press the panel shut; a click indicates it is closed properly.
4. Restore the power from the consumer unit and turn the air conditioner on.

**INDOOR UNIT:** While the unit is disconnected from power dust regularly with a dry cloth or slightly damp paper towel. Never use chemicals or solvents. Never spray a liquid in or over the appliance.

**OUTDOOR UNIT:** While the unit is disconnected from power. Remove dirt and keep the air intake and exhaust openings free of debris, etc. Cleaning with chemicals may cause damage.

## END OF SEASON

If the air conditioner is not going to be used for an extended period:

- Set in fan mode on a slightly warm day so that the inside of the appliance dries out.
- Switch off the power at the fuse box and remove the batteries from the remote control.
- Clean the filters.
- Remove the batteries from the remote control.

## START OF SEASON

If the air conditioner is to be used again after an extended period:

- Check that the air intake and exhaust openings of the interior and exterior units are not blocked. Remove any dirt or debris that has accumulated.
- Check that the filter is installed within the indoor unit and is clean.
- Check that the condensation outlet drains properly and there is no dirt or organic blockage (otherwise leakage may occur)
- Install 2 AAA batteries in the remote control.
- Turn the appliance on, set the time and desired setting.

## REPLACING THE BATTERIES

- Remove the cover from the rear of the remote control.
- Replace the AAA batteries, ensuring the correct polarity.
- Reinstall the cover on the rear of the remote control.
- The display on the remote will start to alternate between the HEAT and COOL symbols. Press any button on the remote when the HEAT symbol is displayed to set the remote up for heating and cooling.
- If nothing is displayed on the remote, try pressing the power button. If still no response, check the polarity of the batteries and try replacing.

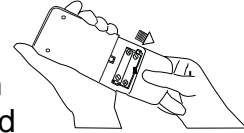

## INSTALLATION GUIDE

### SAFETY

- Only qualified personnel should install this appliance. This installation manual is intended for use by individuals possessing adequate backgrounds and qualifications in electrical, electronic, refrigerant and mechanical fields. Any attempt to install or repair the appliance may result in personal injury and property damage.
- The manufacturer and retailer cannot be responsible for the interpretation of this information, nor can it assume any liability in connection with its use.
- The units are designed for permanent installation.
- The equipment is designed for domestic or office use and we are not making any endorsements for use in industrial or maritime environment.
- Do not place near sources of heat, vapors, industrial machine oil or other flammable gases.
- High-frequency waves generated by radio equipment, welders and medical equipment will interfere with the normal operation of the unit.
- Install this device only when it complies with local/national legislation, ordinances and standards.
- Check the mains voltage and frequency. This unit is only suitable for an earthed electrical supply, connection voltage 230 V~ / 50 Hz. The information, specifications and parameter are subject to change due to technical modifications or improvement without any prior notice. The accurate specifications are presented on the nameplate label.
- Please read this installation manual completely before installing the product.
- When the power cord is damaged, replacement work shall be performed by authorized personnel only.
- Installation work must be performed in accordance with all European, national and / or local directives and standards and must be done by authorized personnel only.
- Always make sure to wear the correct personal safety protections such as protective eyewear, gloves, ear protection etc.
- This air conditioner contains a refrigerant and can be classified as pressurized equipment. Therefore always contact an authorized air conditioning engineer for installation and maintenance of the air conditioner.
- The air conditioner must be inspected and serviced on an annual basis by an authorised air conditioning engineer.



## **INDOOR UNIT POSITION**

The air inlet and outlet vent should be away from any obstruction, ensuring that there is a good airflow through the whole air-conditioned space. Select a position where the condensing water can be easily drained out, and the indoor unit can be easily connected to outdoor unit. The wall where the unit is fixed should be strong enough to withstand the full weight and vibration of the unit. The unit should be accessible for service and maintenance. The height of the installed unit should be ideally more than 200cm from the floor. The air conditioner must not be installed in a wet environment such as a bathroom, shower or swimming pool etc.

## **OUTDOOR UNIT POSITION**

A convenient position, dry and well ventilated, outside of direct sunlight or strong winds, which is not on a flood line and where noise and airflow does not cause interference or inconvenience. Select a location where there are no obstructions to the inlet and outlet vents. The location should be able to withstand the full weight and vibration of the outdoor unit and permit safe installation.

Make sure that the outdoor unit is installed in compliance with the installation dimension diagram with easy maintenance access. Select a place where it is out of reach of children. Do not block utilities access or fire escapes.

The external unit must be lifted and put in place by two people.

## **NOTES:**

1. Only use a power supply with the correct ratings, making sure the correct sized power cables are used
2. The appliance shall be installed in accordance with standard wiring regulations by qualified personnel
3. Only replace fuses according to their printed rating or corresponding pcb boards.

**RECOMMENDED INSTALLATION SPACING DIAGRAM**

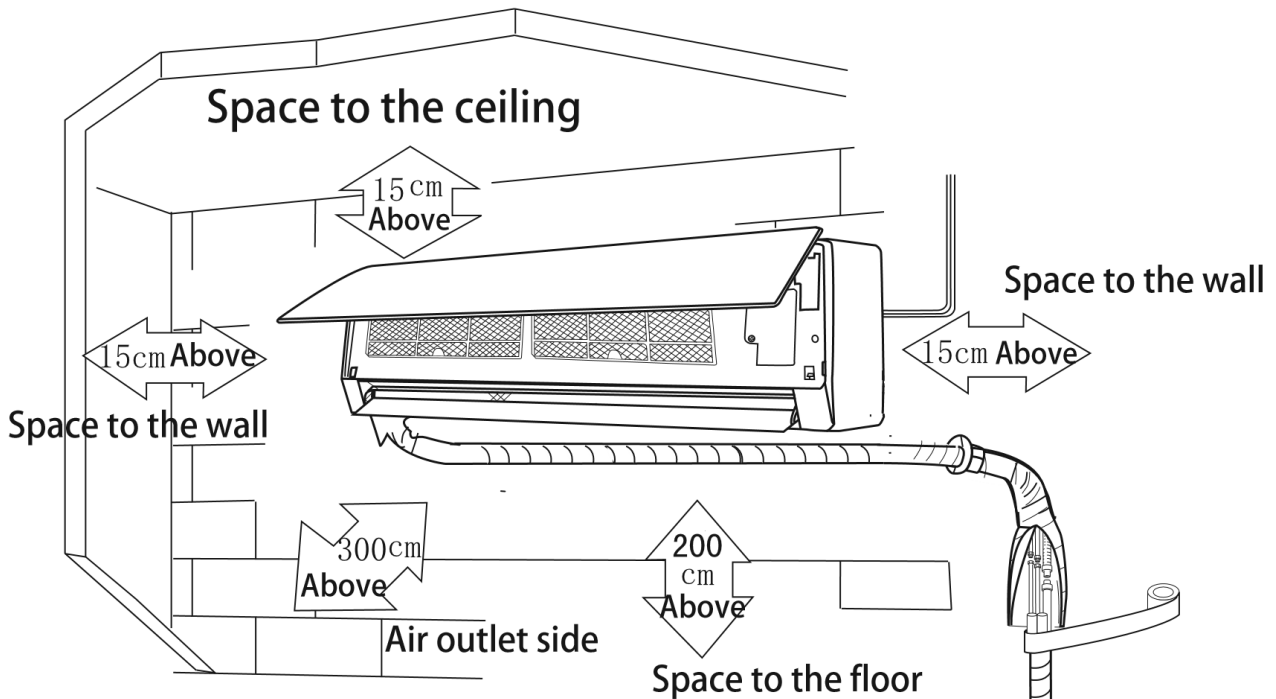

- The dimensions of the space necessary for correct installation of the appliance including the minimum permissible distances to adjacent structures

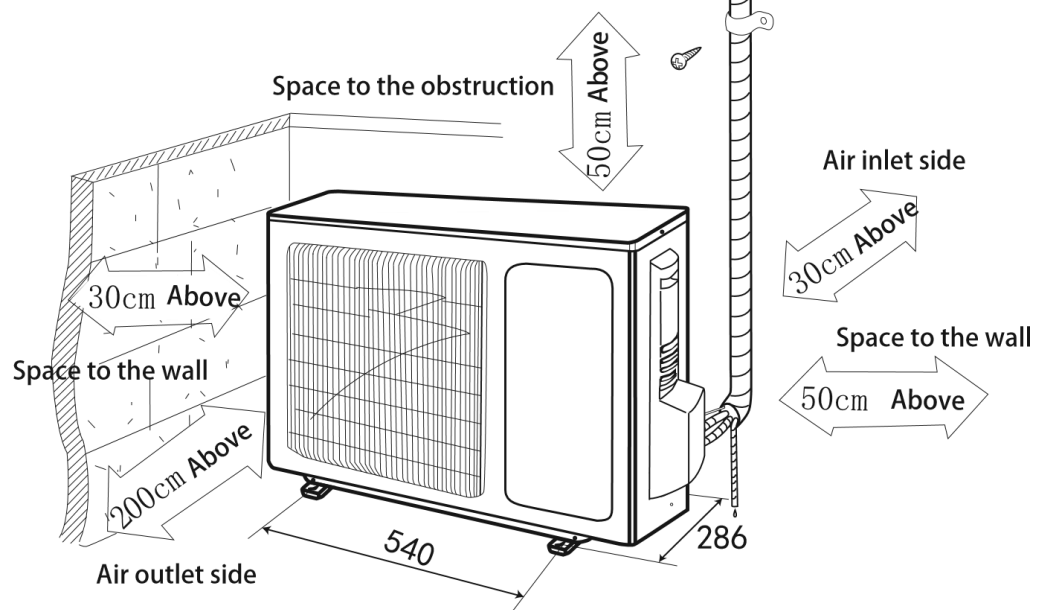

## TOOLS RECOMMENDED FOR INSTALLATION



Electric Drill



Hammer



Screwdrivers



Tape Measure



Core Hole Cutter



Spirit Level



Number 14 (7mm)  
Masonry Drill

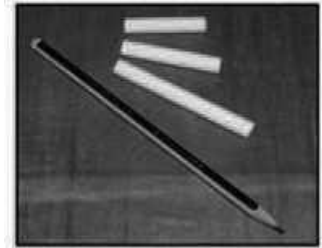

Pencil and Chalk



1.5 inch number 10  
screws



Small Stepladder



7mm Wall Plugs



Protective Glasses  
and Mask



Pipe and Cable  
Detector

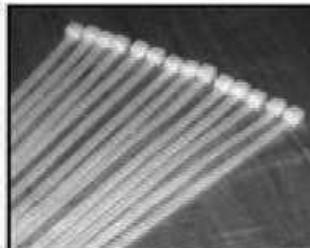

4 inch Plastic Ties



2 Inch Pipe Clips



Circuit Breaker



Garden Gloves  
(For Handling  
Outdoor Unit)



Dust Sheets



Foam Filler



Silicone Sealant  
and gun



1. Check the area for any hidden wires or pipes.



2. Mark the right hand backplate screw position.



3. Remove the backplate and drill a 7mm hole.

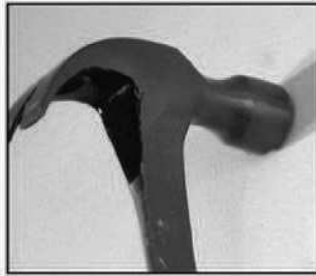

4. Tap a 7mm wall plug into position.

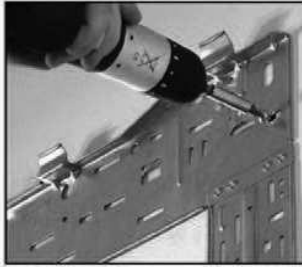

5. Screw the backplate to the wall using 1.5 inch number 10 screws.



6. Check to ensure level, then mark the other holes and swing the backplate away.



7. Drill the rest of the holes and insert the wall plugs.

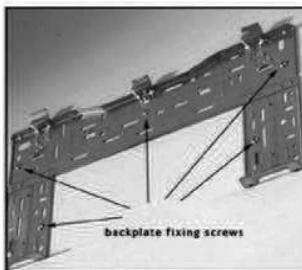

8. Fix the backplate to the wall.

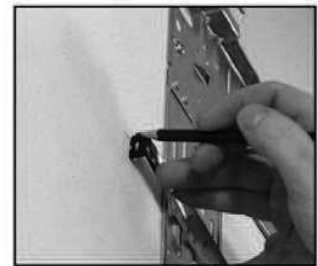

9. Mark the hole centre and make sure the cutter will clear the backplate.



10. Drill the hole at a slight downwards angle. When you feel the pilot drill exit the outside wall stop.



11. Finish the hole from the outside to keep it clean.



12. Feed the cord and drain hose carefully through the wall.



13. Undo the power lead and break out the plastic tab.

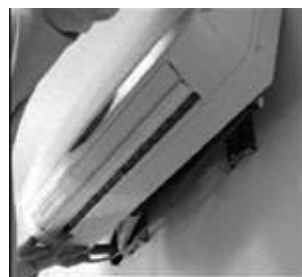

14. Hook the indoor unit onto the top of the backplate.



15. Lock the bottom of the unit onto the base of the backplate.

# INFORMATION REGARDING THE INSTALLATION OF THE INDOOR UNIT

## INSTALLING THE REAR PANEL

1. Always mount the rear panel horizontally. Due to the water tray within the indoor unit we would advise that the outlet of the water tray should be fractionally lower when installing as this will aid drainage of the condensate collected.
2. Fix the rear panel on the wall with screws.
3. Be sure that the rear panel has been fixed firmly enough to withstand the weight of an adult (60Kg), furthermore the weight should be evenly shared by each screw.

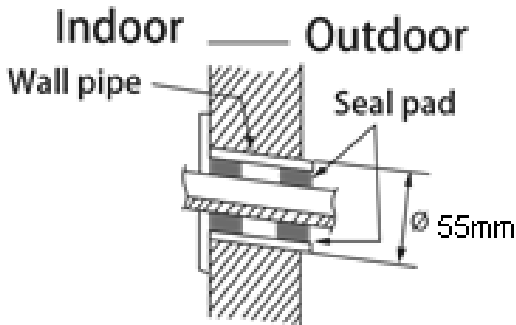
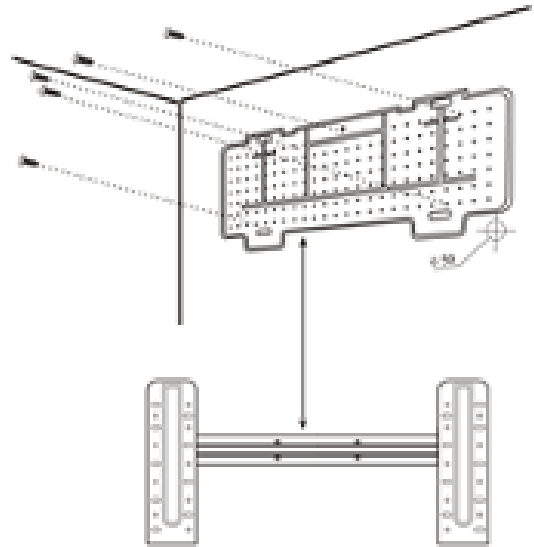

## INSTALLING THE PIPING HOLE

1. Make the piping hole (55mm diameter) in the wall at a slight downward slant to the outdoor side (To aid drainage of the condensate).
2. Insert the piping-hole sleeve into the hole to prevent the connecting piping and wiring from been damaged when passing through the hole.

The piping can be lead out on the right, left or directly behind the indoor unit as seen in fig. 1. Please cut off the pipe hole guards if you are changing the pipe position. The unit also features alternative guards for more pipe positioning.

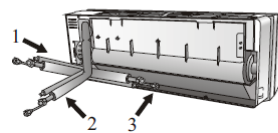
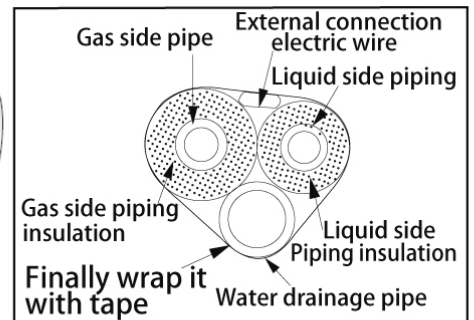

Fig.1



Make sure that the drain pipe is underneath the pipelines. (Fig.3) (When the drain pipe passes the room interior, some condensed water might occur to its surfaces if the humidity is very high).

Tidy up the copper pipes, electrical cables and water drains and pass them through the wall hole drilled earlier (fig.2).

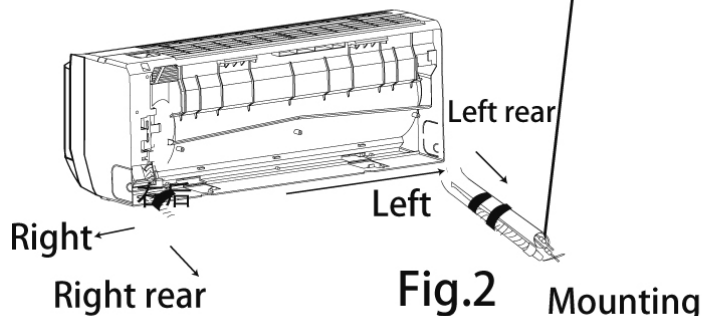

Fig.2

Hang the mounting slots of the indoor unit on the wall mounting bracket making sure is tight in place (fig.3) so that the hooks at the bottom of the indoor unit match the hooks of the wall mounting bracket (fig.4)

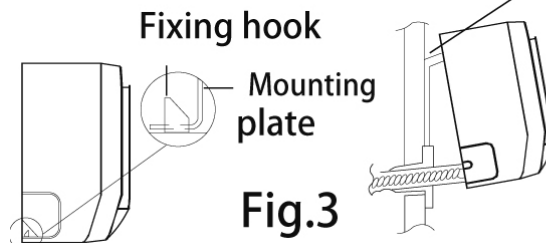
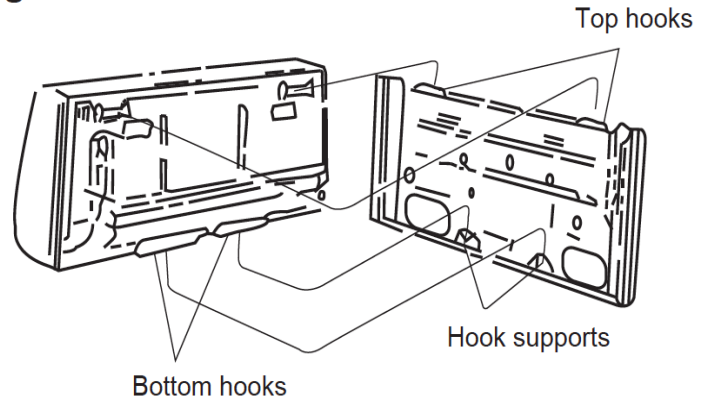

Fig.3

**Notes:**

1. The height of the installed unit is recommended to be > 200 cm.
2. Either the indoor unit or the outdoor unit can be higher, but the height difference must comply with a max. 5 metres level difference.
3. Try to avoid bending the pipes as much as possible so as to avoid possible negative impacts upon the performances of the unit.

**Fig.4**



**INSTALLATION OF THE OUTDOOR UNIT**

Try to move the product to the installation location in its original packaging  
As the gravity center of the unit is not at the installation center, special caution should be taken when using hoisting cables to lift it up  
During transport, the outdoor unit must not be tilted to over 45 degrees (also do not store the unit horizontally).  
Use expansion bolts to fix the mounting supports on the wall;  
Use bolts and nuts to fix the outdoor unit firmly on the supports and keep on the same level;  
If the unit is installed on the wall or at the rooftop, the supports have to be firmly fixed so as to resist earthquakes or strong wind.  
Dimensions for parallel units installations

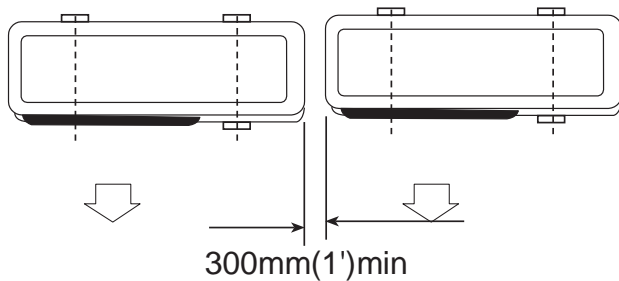

**CONDENSATE DRAINAGE OF THE OUTDOOR UNIT**

When operating in heating mode condensate will collect and drain through the base of the outdoor unit. The air conditioner is supplied with an elbow joint which can be connected to the underside of the outdoor unit for drainage.

1. Connect the elbow joint to the drainage hole on the underside of the outdoor unit.
2. Connect a drain hose (not supplied) to the elbow joint and run downhill to your chosen drainage point.

Please note: The drainage is gravity fed, and so must run downhill.

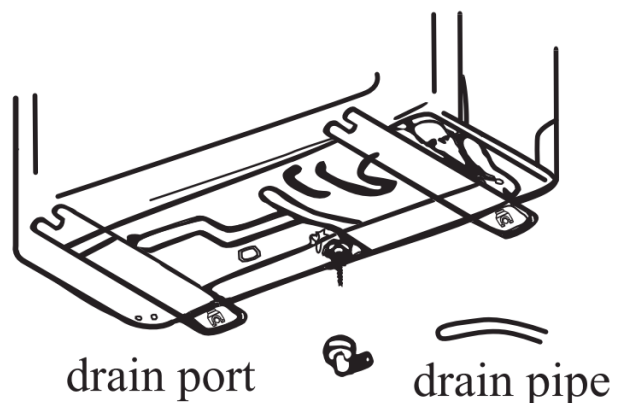

## STANDARD PIPELINES CONNECTION & AIR PURGING

No dust or any other particles, air or moisture should be allowed to enter the air conditioning system. Careful attention should be paid when pipeline connection for outdoor unit is made. Try to avoid repeated curves as much as possible; otherwise damage to the copper pipes may occur. Suitable wrenches should be used when the pipeline connection is done so as to ensure appropriate torque (refer to following torque table).

Excessive torque action might damage the joints while too little torque might lead to leakage.

Torque based upon the wrench to be used

| Copper pipe diam. | Tightening torque      | Strengthened tightening torque |
|-------------------|------------------------|--------------------------------|
| 6.35(1/4")        | 160kgf.cm(63kgf.inch)  | 200kgf.cm(79kgf.inch)          |
| 9.52(3/8")        | 300kgf.cm(118kgf.inch) | 350kgf.cm(138kgf.inch)         |
| 12.7(1/2")        | 500kgf.cm(197kgf.inch) | 550kgf.cm(216kgf.inch)         |
| 15.88(5/8")       | 750kgf.cm(295kgf.inch) | 800kgf.cm(315kgf.inch)         |

### AIR PURGING WITH VACUUM PUMP

1. Check that pipelines connection have been properly connected, remove the charging port cap, and connect the manifold gauge and the vacuum pump to the charging valve by service hoses as shown
2. Open the valve of the low-pressure side of manifold gauge, then run the vacuum pump. Vacuum the indoor unit and the connecting pipes until the pressure in them lowers to below 1.5mmHG (The operation time for vacuuming is about 10 minutes). When the desired vacuum is reached, close the valve of the low pressure of the manifold and stop the vacuum pump.
3. Disconnect the service hoses and fit the cap to the charging valve.
4. Remove the blank caps, and fully opens the spindles of the 2-way and 3-ways valves with a service valve wrench.
5. Tighten the blanking caps of the 2-way and 3-ways valves, applying the above torque Table

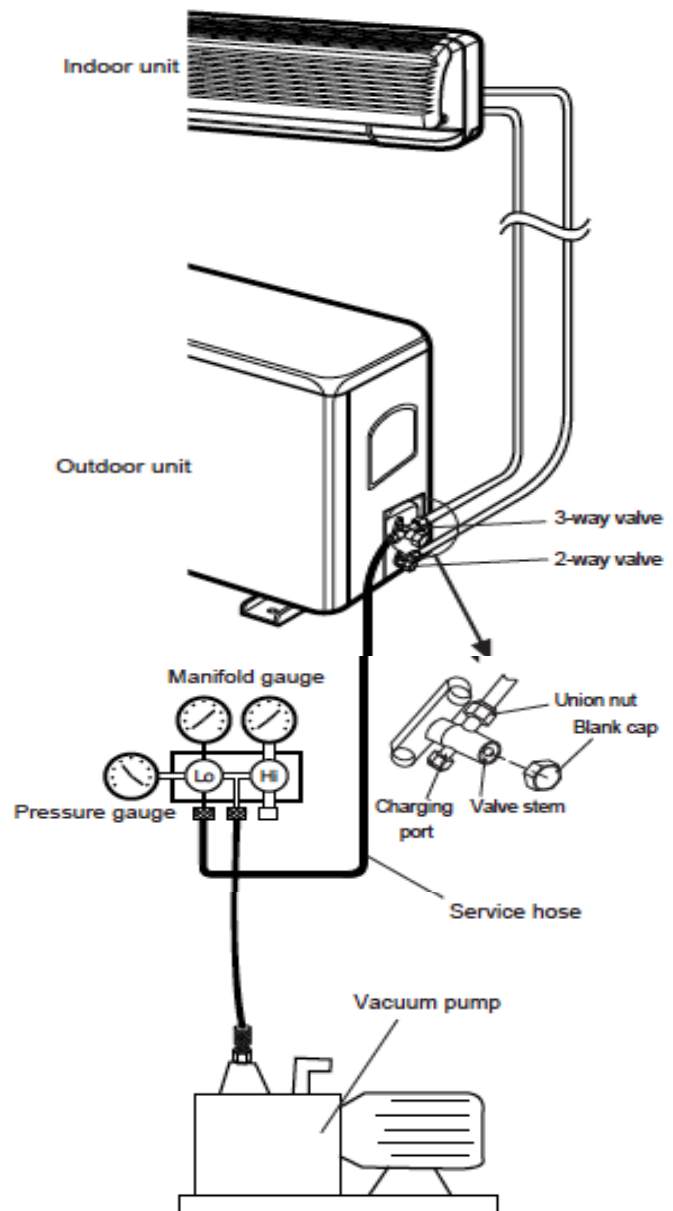

Fig.6

### ADDING REFRIGERANT

Refrigerant must be added if the pipe length is more than 5 metres (16'5"). This operation can only be performed by a professional F-Gas engineer, for the additional gas amount, see the below

| Liquid pipe diameter | Additional Refrigerant   | Additional Refrigerant                      |
|----------------------|--------------------------|---|
| Φ6.3 or Φ6 (1/4)     | 15g per each meter added | Total length of pipe run – 5 meters) x 15 g |
| Φ9.52 or Φ9 (3/8)    | 25g per each meter added | Total length of pipe run – 5 meters) x 25 g |

### GAS LEAKAGE INSPECTION

After the pipeline connection is done, use a leakage inspection device to carefully check if there is any leakage at the joints. This is an important step to ensure the quality of installation. Once a leak is detected, proper action should be taken immediately.

### INSTALL THE WATER DRAINAGE PIPE



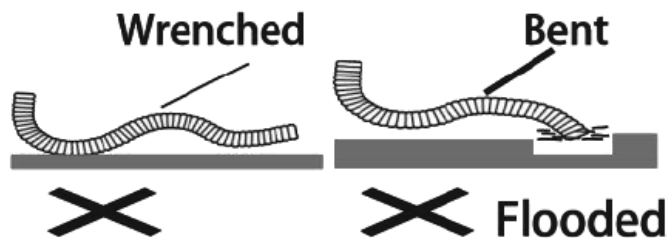



1. For good drainage, the drain hose should be angled downwards.
2. Do not pull on or bend the drain hose or flood its end with water.
3. When the long drainage hose passes through indoor areas, it should be wrapped in insulation.



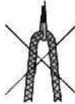
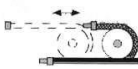
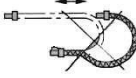

**NOTES:**

The copper pipe used in the refrigeration lines are very soft, high pressure copper and prone to get damaged if not handled correctly. Try to avoid bending or stretching the pipework. Always ensure the pipes are protected when running through the wall to help prevent damage to the pipes.

|   |   |   |   |
|---|---|---|---|
| <p>To keep the allowed bending radius please make the packed soft pipes vertical before extending</p> |    |    | <p>Please do not extend only one side of the packed soft pipes.</p> |
| <p>Please make use of semicircle pulley to keep the allowed bending angle</p>                         |    |    | <p>Extreme bending could damage the pipes</p>                       |
| <p>Please use a twisting wheel to avoid improper bending.</p>   |  |   | <p>Over bent soft pipes will lead to irregular bending</p>          |
| <p>Please use rigid elbow to keep the bending angle while soft pipes operating.</p>                   |  |  | <p>Undersize bending will damage the soft pipe.</p>                 |
| <p>Please keep the minimum bending angle while installing</p>   |  |  | <p>Do not use short sharp angle bends.</p>                          |

## ELECTRICAL CONNECTION OF THE AIR CONDITIONER

- The electrical connections can be found under the protective plastic cover. Remove this from the side of the outdoor unit to gain access to the electrical connections.
- Connect the indoor power and control wires with the matching outdoor wire as per the electrical diagram.
- Do not attempt to connect the wires in a different way to the diagram on the air conditioner as this could damage the unit and invalidate the warranty.
- Secure the wires and replace the cover before operating the unit.
- The appliance should be installed in accordance with national wiring regulations.
- If the supply cord is damaged, it must be replaced by the manufacturer, its service agent or a suitably qualified person in order to avoid a hazard.
- The air conditioner electrical wiring must follow the specific country regulations. If power cord is damaged must be replaced by a qualified electrician.

### iQool9(B) – iQool18(B)

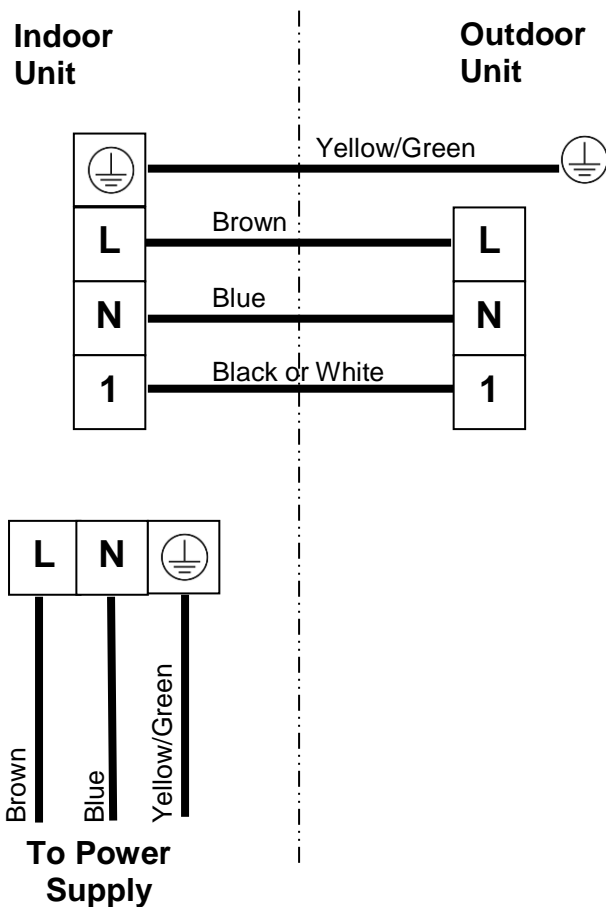

### iQool24(B)

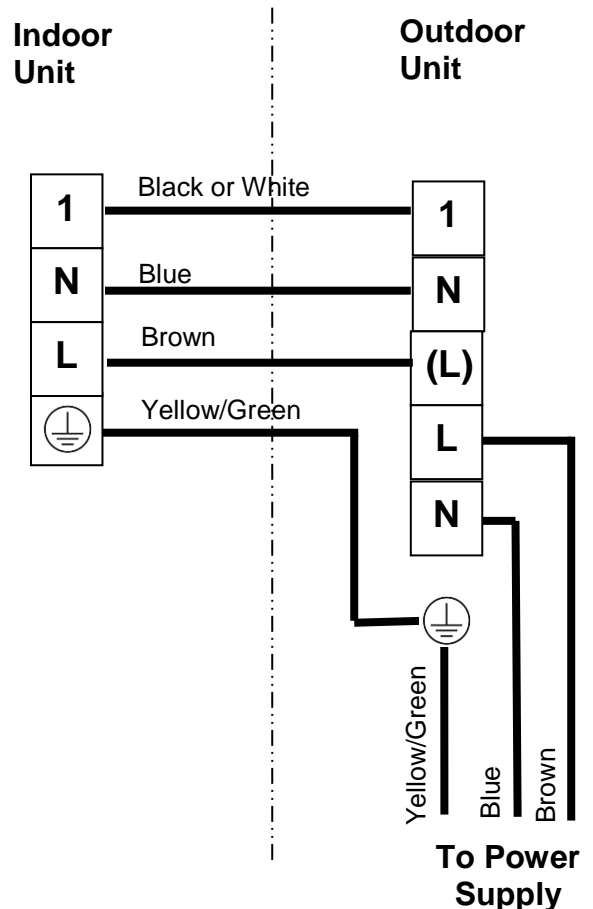

# ELECTRICAL WIRING DIAGRAMS

Please note: The diagrams provided in the manual are for guidance only. Due to continual product development the diagrams provided on the units themselves should be followed where any discrepancies are found

## iQool9(B), iQool12(B), iQool18(B)

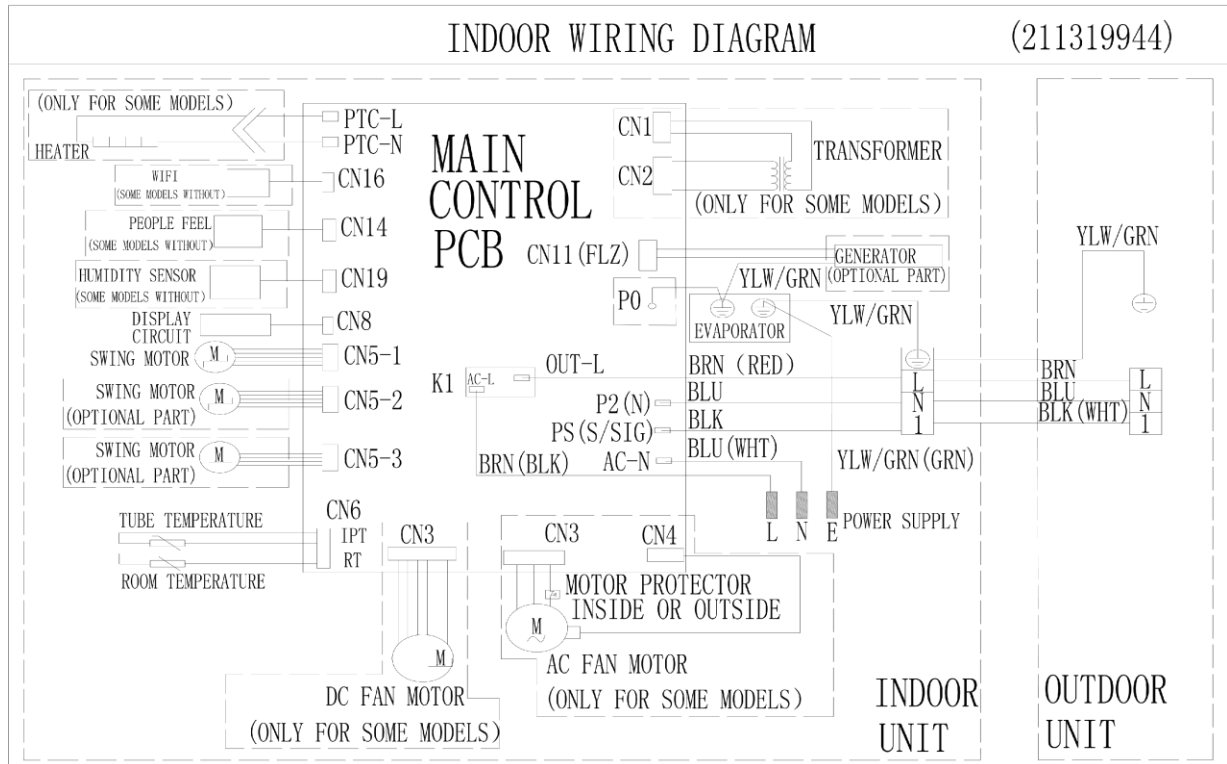

## OUTDOOR WIRING DIAGRAM

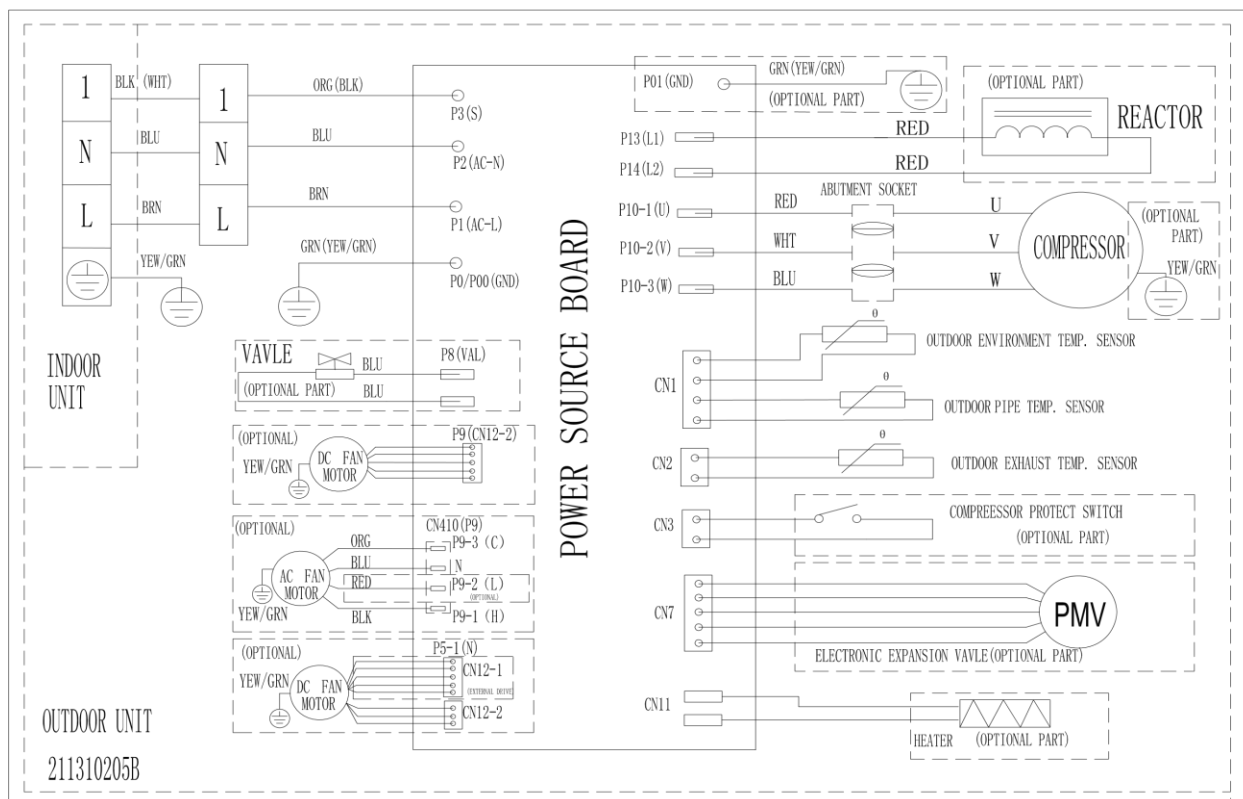

# iQool24(B)

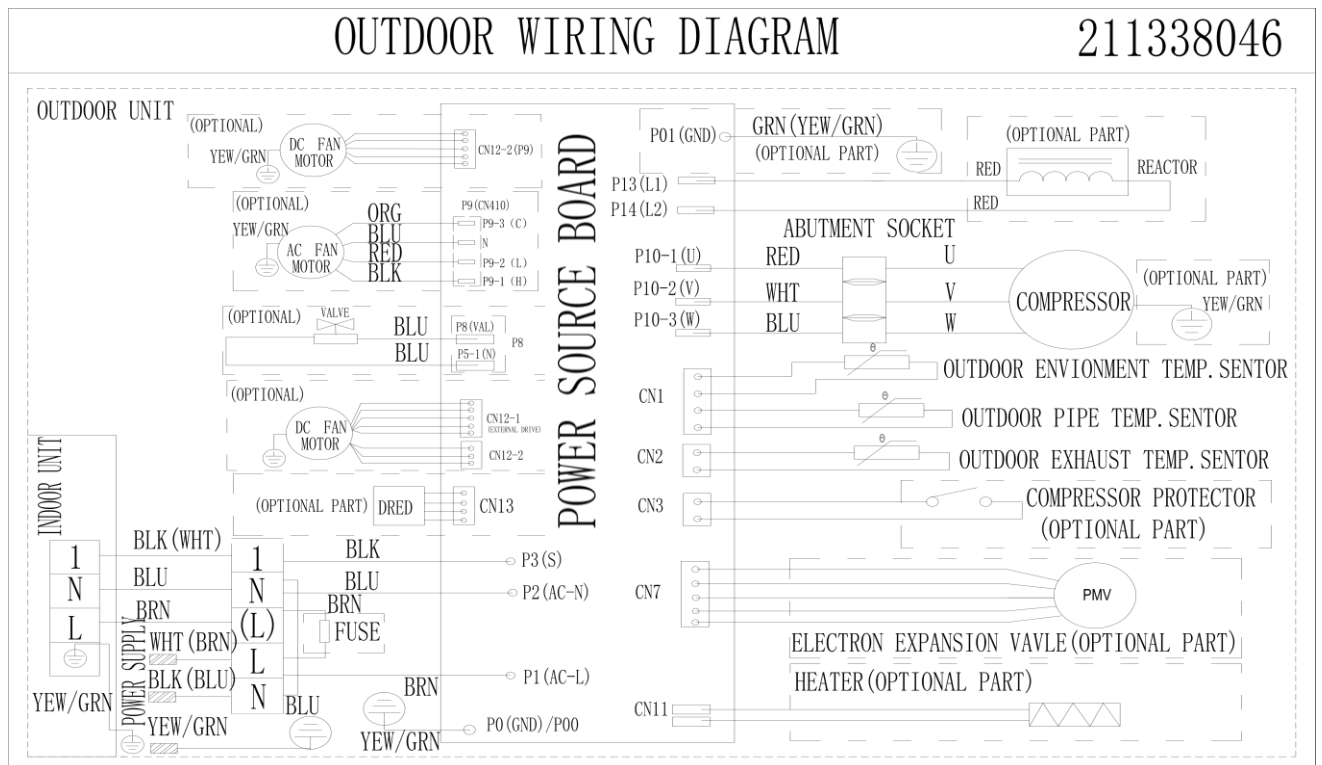
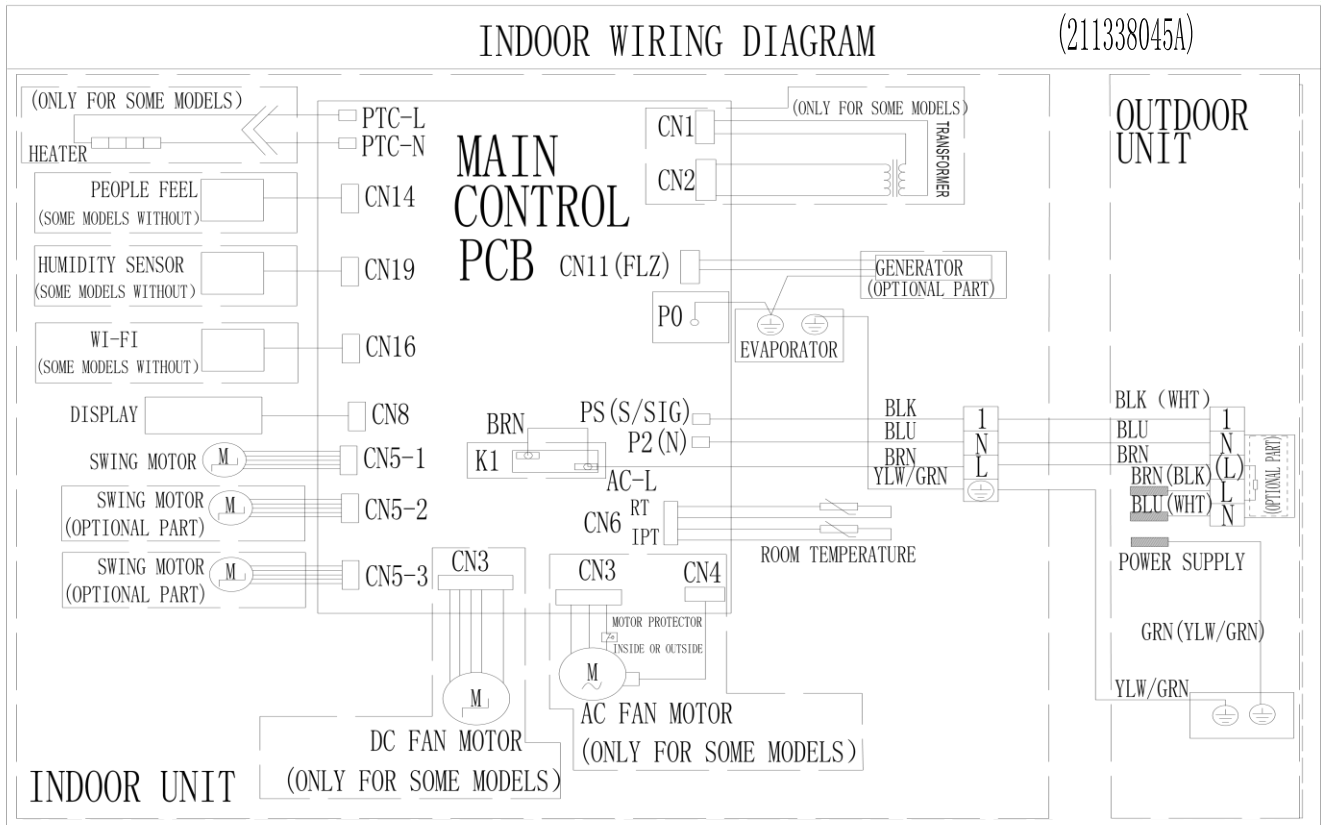

## TROUBLESHOOTING AND SELF DIAGNOSIS

| MALFUNCTION   | POSSIBLE CAUSE  |
|---|---|
| The appliance does not operate  | Power failure   |
|   | Damaged indoor/outdoor unit fan motor   |
|   | Faulty compressor thermomagnetic circuit breaker  |
|   | Faulty protective device or fuses   |
|   | Loose connections   |
|   | Self protection in adverse conditions   |
|   | Voltage higher / lower than the voltage range   |
|   | Active TIMER-ON function  |
|   | Damaged electronic control board  |
| Strange odour   | Air filter dirty  |
| Noise of running water  | Back flow of liquid in the refrigerant circulation  |
| A fine mist comes from the air outlet   | This occurs when the air in the room becomes very cold, for example in the COOLING or DEHUMIDIFYING modes.                              |
| A strange noise can be heard  | This noise is made by the expansion or contraction of the front panel due to variations in temperature and does not indicate a problem. |
| Insufficient airflow, either hot or cold  | Inappropriate temperature setting.  |
|   | Air inlet or outlet of indoor or outdoor unit has been blocked.   |
|   | Air filter is blocked.  |
|   | Fan speed set at minimum.   |
|   | Other sources of heat in the room.  |
| The appliance does not respond to commands  | No refrigerant.   |
|   | Remote control is not near enough to indoor unit.   |
|   | Battery in Remote controller may have been exhausted..  |
| The display is off  | Obstacles between remote control and signal receiver in indoor unit.  |
|   | Active LED function   |
| Remote cannot select heating mode.  | Power failure   |
|   | Remove the batteries from the remote and follow the guide for setting up the remote.  |
| <b>Switch off the air conditioner immediately and cut off the power supply in the event of:</b> |   |
| Strange noises during operation.  |   |
| Faulty electronic control board   |   |
| Faulty fuses or switches.   |   |
| Spraying water or objects inside the appliance.   |   |
| Overheated cables.  |   |
| Very strong smells coming from the appliance.   |   |

**ERROR SIGNALS ON THE DISPLAY**

In case of error, the display on the indoor unit shown the following error codes:

| <b>Error Code</b>                   | <b>Light flash code</b>                    | <b>Failure type</b>                                     |
|-------------------------------------|--|---|
| E0                                  | Run & Timer – both blinking                | Indoor and outdoor communication failure                |
| EC                                  | Run & Timer – both blinking                | Outdoor communication failure                           |
| E1                                  | Run – 1 flash every 8 seconds              | Indoor room temperature sensor                          |
| E2                                  | Run – 2 flashes every 8 seconds            | Indoor coil temperature sensor                          |
| E3                                  | Run – 3 flashes every 8 seconds            | Outdoor coil temperature sensor                         |
| E4                                  | Run – 4 flashes every 8 seconds            | System abnormality                                      |
| E5                                  | Run – 5 flashes every 8 seconds            | Model configuration wrong                               |
| E6                                  | Run – 6 flashes every 8 seconds            | Indoor fan motor fault                                  |
| E7                                  | Run – 7 flashes every 8 seconds            | Outdoor temperature sensor                              |
| E8                                  | Run – 8 flashes every 8 seconds            | Exhaust temp. sensor                                    |
| E9                                  | Run – 9 flashes every 8 seconds            | IPM drive and module fault                              |
| EF                                  | Run – 10 flashes every 8 seconds           | Outdoor fan motor fault (DC motor)                      |
| EA                                  | Run – 11 flashes every 8 seconds           | Current sensor fault                                    |
| EE                                  | Run – 12 flashes every 8 seconds           | EEPROM fault  |
| EP                                  | Run – 13 flashes every 8 seconds           | Temp. switch fault ( on top of the compressor)          |
| EU                                  | Run – 14 flashes every 8 seconds           | Voltage sensor fault                                    |
| <b>Protection Display Code List</b> |  |   |
| P1                                  | Run and Timer – 1 flash every 8 seconds    | Overvoltage /lower voltage protection                   |
| P2                                  | Run and Timer – 2 flashes every 8 seconds  | Overcurrent protection                                  |
| P4                                  | Run and Timer – 4 flashes every 8 seconds  | Exhaust over temperature protection                     |
| P5                                  | Run and Timer – 5 flashes every 8 seconds  | Too cool protection in cooling mode                     |
| P6                                  | Run and Timer – 6 flashes every 8 seconds  | Overheat protection in cooling mode                     |
| P7                                  | Run and Timer – 7 flashes every 8 seconds  | Overheat protection in heating mode                     |
| P8                                  | Run and Timer – 8 flashes every 8 seconds  | Outdoor over temperature / lower temperature protection |
| P9                                  | Run and Timer – 9 flashes every 8 seconds  | Drive protection (software control )                    |
| P0                                  | Run and Timer – 10 flashes every 8 seconds | Module protection (hardware control)                    |

## OUTDOOR UNIT FAULT CODES

The outdoor unit has an LED on the power board. This LED will be illuminated when the compressor is running and blink 1s on and 1s off when the compressor is in standby. If there is a fault on the outdoor unit, it will blink on and off for half a second at a time, followed by a 3s gap. The number of consecutive blinks will show the fault as per the table below:

| No. of blinks | Fault   |
|---------------|---|
| 1             | IPM protection  |
| 2             | Over voltage /lower voltage   |
| 3             | Overcurrent   |
| 4             | Exhaust over temperature protection   |
| 5             | Outdoor coil over temperature protection  |
| 6             | Drive fault and protection (V1, VP1)  |
| 7             | Communication fault with indoor unit  |
| 8             | Compressor overheat fault (compressor top switch)                               |
| 9             | Short-circuit / open-circuit fault of outdoor temperature sensor                |
| 10            | Short circuit / open-circuit fault of outdoor heat exchanger temperature sensor |
| 11            | Short-circuit / open-circuit fault of exhaust temperature sensor                |
| 12            | Voltage sensor fault  |
| 13            | Current sensor fault  |
| 14            | IPM fault   |
| 15            | Communication fault between power source board and IPM                          |
| 16            | No feedback from DC fan motor(outdoor unit)                                     |
| 17            | Defrost state   |

## WIFI CONTROL TROUBLESHOOTING

| Description                                      | Possible Cause   |
|--|--|
| Air conditioner can't be configured successfully | <ol style="list-style-type: none"> <li>1. Check the mobile device is connected to WIFI</li> <li>2. Check the AC is connected</li> <li>3. Check that any firewall or other restrictions are causing problems</li> <li>4. Check the router is functioning normally</li> <li>5. Check that the router isn't blocking the App</li> </ol>   |
| Mobile device can't control the air conditioner  | <p>The app displays "Identification failed". This indicates that the AC has been reset and the mobile device has lost contact with the AC. Reconnect the device following the above instructions. If this fails, delete the AC from your devices list and start the install process from the beginning.</p>  |
| Mobile device can't find AC                      | <p>The app displays "Air conditioner offline". Check the below:</p> <ol style="list-style-type: none"> <li>1. The AC has been reconfigured</li> <li>2. The AC is not receiving power</li> <li>3. The router is not powered on</li> <li>4. The AC can't connect to router</li> <li>5. The AC can't connect to network through the router</li> <li>6. The mobile device can't connect to the router</li> <li>7. The mobile device can't connect to a network (when being used remotely)</li> </ol> |



## TECHNICAL SPECIFICATION

| Model                                      | iQool9 – V4<br>iQool9B                 |                                | iQool12 – V4<br>iQool12B |                                | iQool18 – V4<br>iQool18B |                                 | iQool24 – V4<br>iQool24B |                                  |  |
|--|--|--------------------------------|--------------------------|--------------------------------|--------------------------|---------------------------------|--------------------------|----------------------------------|--|
| Rated voltage and frequency<br>(Ph-V-Hz)   | 1Ph/220-240V~/50Hz                     |                                | 1Ph/220-240V~/50Hz       |                                | 1Ph/220-240V~/50Hz       |                                 | 1Ph/220-240V~/50Hz       |                                  |  |
| Fuse Required                              | 13A                                    |                                | 13A                      |                                | 13A                      |                                 | 16A                      |                                  |  |
| Mode                                       | Cooling                                | Heating                        | Cooling                  | Heating                        | Cooling                  | Heating                         | Cooling                  | Heating                          |  |
| Rated capacity (W)                         | 2600<br>(940~<br>3320)                 | 2610<br>(940~<br>3380)         | 3400<br>(1000~<br>3770)  | 3420<br>(1000<br>~<br>3810)    | 5130<br>(1250~<br>5920)  | 5230<br>(1350~<br>6280)         | 6810<br>(1830~<br>7810)  | 6870<br>(1850~79<br>30)          |  |
| Power input (W)                            | 750<br>(240~<br>1230)                  | 752<br>(240~<br>1280)          | 1010<br>(290~<br>1320)   | 948<br>(290~<br>1400)          | 1530<br>(330~<br>2250)   | 1550<br>(340~<br>2350)          | 1980<br>(410~<br>2800)   | 2050<br>(420~<br>3000)           |  |
| Current input (A)                          | 4.0(1.2~6.3<br>)                       | 4.1(1.2<br>~6.5)               | 4.7(1.5~<br>6.7)         | 4.5(1.5<br>~7.0)               | 7.2(1.7~1<br>0.8)        | 7.3(1.7~1<br>2.0)               | 8.9(2.3~1<br>2.5)        | 9.0(2.3~1<br>3.7)                |  |
| SEER/SCOP(W/W)                             | 6.5/A++                                | 4.0/A+                         | 6.5/A++                  | 4.0/A+                         | 6.3/A++                  | 4.0/A+                          | 6.5/A++                  | 4.1/A+                           |  |
| Nominal load (kW)                          | 2.60                                   | 2.61                           | 3.40                     | 3.42                           | 5.13                     | 5.23                            | 6.81                     | 6.87                             |  |
| Balance point temperature<br>heating (°C)  | /                                      | -7                             | /                        | -7                             | /                        | -7                              | /                        | -7                               |  |
| Min. outdoor operating<br>temperature (°C) | /                                      | -15                            | /                        | -15                            | /                        | -15                             | /                        | -15                              |  |
| Thermostat-off mode (W)                    | 35                                     |                                | 35                       |                                | 45                       |                                 | 45                       |                                  |  |
| Standby mode (W)                           | 2                                      |                                | 2                        |                                | 2.5                      |                                 | 2.5                      |                                  |  |
| Off mode (W)                               | 0                                      |                                | 0                        |                                | 0                        |                                 | 0                        |                                  |  |
| Annual consumption (kW)                    | 140                                    | 735                            | 183                      | 840                            | 283                      | 1575                            | 366                      | 1878                             |  |
| Copper Pipe Type length                    | 5m                                     |                                | 5m                       |                                | 5m                       |                                 | 5m                       |                                  |  |
| Liquid side / Gas side<br>(mm/inch)        | 6.35 (1/4) + 9.52 (3/8)                |                                | 6.35 (1/4) + 9.52 (3/8)  |                                | 6.35 (1/4) + 9.52 (3/8)  |                                 | 6.35 (1/4) + 12.7 (1/2)  |                                  |  |
| Max. refrigerant pipe length               | 25m                                    |                                | 25m                      |                                | 25m                      |                                 | 25m                      |                                  |  |
| Max. elevation                             | 10m                                    |                                | 10m                      |                                | 10m                      |                                 | 10m                      |                                  |  |
| Interconnecting Cable                      | 4x1.0mm <sup>2</sup>                   |                                | 4x1.0mm <sup>2</sup>     |                                | 4x1.5mm <sup>2</sup>     |                                 | 4x0.75mm <sup>2</sup>    |                                  |  |
| Fuse Rating                                | 4A on indoor PCB                       |                                | 4A on indoor PCB         |                                | 4A on indoor PCB         |                                 | 4A on indoor PCB         |                                  |  |
| Moisture Removal (L/h)                     | 0.9                                    |                                | 1.1                      |                                | 1.5                      |                                 | 1.8                      |                                  |  |
| Built In Ioniser                           | No                                     |                                | No                       |                                | No                       |                                 | No                       |                                  |  |
| Indoor                                     | Air Flow (m <sup>3</sup> /h)           | 420                            |                          | 550                            |                          | 800                             |                          | 970/980                          |  |
|  | Dimensions (L*W*H)<br>(mm)             | 692x255x190<br>700x255x198 (B) |                          | 775x250x195<br>765x245x205 (B) |                          | 900x290x203<br>885x295x218 (B)  |                          | 1003x315x220<br>1005x315x225 (B) |  |
|  | Packaging (L*W*H)<br>(mm)              | 770x325x265<br>768x330x280 (B) |                          | 840x315x260<br>830x323x270 (B) |                          | 980x375x285<br>1100x400x300 (B) |                          | 1096x390x297<br>1100x400x300 (B) |  |
|  | Net / Gross weight<br>(Kg)             | 7.9/9.6<br>8.6/10.0 (B)        |                          | 8.8/10.5<br>9.5/11.3 (B)       |                          | 11.1/13.1<br>11.8/13.8 (B)      |                          | 13.3/16<br>15/17 (B)             |  |
|  | Noise – Sound<br>pressure level (dB/A) | 22~40                          |                          | 22~40                          |                          | 27~43                           |                          | 30~44                            |  |

|                |                                     |   |   |   |   |
|----------------|-------------------------------------|---|---|---|---|
|                | Noise – Sound power level (dB/A)    | 32~50                                       | 32~50                                       | 37~53                                       | 40~54                                       |
| <b>Outdoor</b> | Dimension (L*W*H) (mm)              | 785x290x500<br>770x290x500 (B)              | 775x290x500<br>775x290x492 (B)              | 780x600x350<br>865x595x350 (B)              | 910x690x370<br>895x693x375 (B)              |
|                | Packaging (L*W*H) (mm)              | 845x335x555<br>850x345x555 (B)              | 845x340x550<br>840x340x545 (B)              | 900x670x385<br>900x635x385                  | 970x760x435<br>965x758x435                  |
|                | Net / Gross Weight (Kg)             | 23.4/27.5<br>24.6/26.5 (B)                  | 22.7/25.8<br>24.8/27.3 (B)                  | 34/36.8<br>34.3/37.2 (B)                    | 39.3/44.6<br>41.3/44.3 (B)                  |
|                | Noise – Sound pressure level (dB/A) | 50  | 50  | 55  | 57  |
|                | Noise – Sound power level (dB/A)    | 60  | 60  | 65  | 67  |
|                | Refrigerant type/weight             | R32/530g                                    | R32/550g                                    | R32/920g                                    | R32/1060g                                   |
|                | Defrost mode                        | Automatic defrosting                        | Automatic defrosting                        | Automatic defrosting                        | Automatic defrosting                        |
|                | Applicable climate types            | Cooling (0°C – 53°C)<br>Heating(0°C – 30°C) | Cooling (0°C – 53°C)<br>Heating(0°C – 30°C) | Cooling (0°C – 53°C)<br>Heating(0°C – 30°C) | Cooling (0°C – 53°C)<br>Heating(0°C – 30°C) |



Consult the manufacturer's manual for safe use of R32

Due to continuous product development process specification may change.

These units contain a gas governed by F-Gas regulations. The gas must be handled by qualified F-Gas engineers.

## APPENDIX



Disposal: Do not dispose this product as unsorted municipal waste. Collection of such waste must be handled separately as special treatment is necessary. Recycling facilities are now available for all customers at which you can deposit your old electrical products. Customers will be able to take any old electrical equipment to participating sites run by their local councils. Please remember that this equipment will be further handled during the recycling process, so please be considerate when depositing your equipment. Please contact the local council for details of your local household waste recycling centres.

## WARRANTY INFORMATION

**electriQ** guarantee provides cover against material or manufacturing faults. This means that if your air conditioner develops a fault during the guarantee period, we will arrange for it to be repaired or replaced.

Faults arising from a faulty installation are specifically excluded.

The system must be serviced annually by qualified personnel.

This unit must be operated under conditions as recommended in this user manual, at voltages indicated on the unit. Any attempts made to service or modify the unit by unqualified person, will render this WARRANTY VOID.

This warranty is in addition to, and does not affect, your statutory rights.

Our warranty is RTB warranty and cover parts and labour only.

We recommend that you note the details of your purchase below and retain your original proof of purchase receipt with this manual. Keep these documents safe in the event of a warranty claim.

Purchase Date: \_\_\_\_\_

Retailer name: \_\_\_\_\_

Model number: \_\_\_\_\_

Serial number: \_\_\_\_\_

Installation Date: \_\_\_\_\_

Installer name: \_\_\_\_\_

Service Date: \_\_\_\_\_

Engineer/ Company name: \_\_\_\_\_

### electriQ UK SUPPORT

[www.electriQ.co.uk/support](http://www.electriQ.co.uk/support)

Please, for your own convenience, check the troubleshooting guide before calling the service line.

If the unit still fails to operate call: 0871 620 1057 or complete the online form

Office hours: 9AM - 5PM Monday to Friday

[www.electriQ.co.uk](http://www.electriQ.co.uk)

Unit J6, Lowfields Way

Elland, West Yorkshire

HX5 9DA